

Impact of Electric Vehicles on Power System with High Wind Power Penetration

Mahmoud Essam M. Harby¹, Luis Marroyo², Javier Marcos³, S.E. Elmasry⁴, Adel El Samahy⁵

^{1,4,5}Electrical Power and Machines Engineering, Faculty of Engineering, Helwan University, Egypt

^{2,3}Electrical and Electronic Engineering, Faculty of Engineering, Public University of Navarra (UPNA), Spain
Medsol project

¹eng_mahmoudessam@yahoo.com, ²luisma@unavarra.es, ³javier.marcos@unavarra.es,

⁴drsaidelmasry@hotmail.com, ⁵el_samahya@yahoo.com

Abstract: The rising energy independence and environmental concerns are key drivers in the growing popularity of electric vehicles (EVs). Because of the intermittent nature of the renewable energy sources, this may cause a high-frequency oscillation of the power system. From another aspect, all the EVs have in common the batteries, which provide the storage capability that can be effectively harnessed when the vehicles are integrated into the grid. Such a storage capability can effectively integrate wind power into the grid and all indicators signalize that the EVs are the most promising technology of the future transportation system. In this paper, different case studies are applied on one area power system to show the effect of the high wind energy penetration on the power system frequency and how the EVs can play an effective role in mitigating the power system frequency oscillation and supporting the more penetration of the wind energy into smarter electrical grids. In addition, an advanced controller has been designed to improve the frequency response and to compensate the delay of the system. The designed controller is a genetic algorithm (GA) based PID (proportional-integral-derivative) controller, it has been proposed for tuning optimized PID parameters. The results show that the controller has played an effective role in decreasing the response overshoot and settling time when used with the EVs. The used variable load, the thermal power plant parameters, and the wind turbine parameters are the same for the five case studies [1].

[Mahmoud Essam M. Harby, Luis Marroyo, Javier Marcos, S.E. Elmasry, Adel El Samahy. **Impact of Electric Vehicles on Power System with High Wind Power Penetration**. *Rep Opinion* 2018;10(10):12-17]. ISSN 1553-9873 (print); ISSN 2375-7205 (online). <http://www.sciencepub.net/report>. 2. doi:[10.7537/marsroj101018.02](https://doi.org/10.7537/marsroj101018.02).

Keywords: Smart grid, large-scale wind energy, electric vehicles, vehicle-to-grid, system frequency oscillation, electrical energy storage systems.

1. Introduction

There are escalating anxieties nowadays about energy independence. Thus, this topic is a major political issue. In the recent twenty years, the world electrical energy generated from the renewable energy systems has been exploding, this is due to the many benefits of the renewable energy systems such as their abundant availability, helping in stabilizing the global energy prices, low running and maintenance cost and reduced carbon emissions [2].

The renewable resources are changeable, which leads to an imbalance between the generated power and the load demand, causing instability or oscillation on the power system frequency, this imbalance may cause a significant loss of loads or generation units, especially in small power systems like Canary Islands power system in the Atlantic Ocean and hence, the power system reliability will be affected due to this imbalance [1].

The ability to store energy when the supply or power generation from the renewable energy source exceeds the demand will be the door to the optimal exploiting of renewable energy. Because most of the renewable energy sources are changeable, so the storage is the suitable solution for both the times, they

are available and not needed and those times when they are needed and not available. The basic idea is to keep exploiting the renewable energy source and power generation, regardless of the demand.

If the demand is less than the generated power from the renewable resource, the excess is diverted to a specific storage system. From another aspect, conventional energy storage systems reduce the energy efficiency and require an extra cost, infrastructure, a wide space and complex control system. Because of the several disadvantages of the conventional energy storage systems, new techniques and modern storage systems have been developed, one of these techniques is the usage of the electric vehicles (EVs) as a modern storage system.

EVs have already entered the consumer automotive market and they will be an integral part of the electrical power system. There are three main types of electric vehicles, HEVs (Hybrid Electric Vehicles) like the Honda Civic Hybrid and Toyota Camry Hybrid, BEVs (Battery Electric Vehicles) such as BMW i3 and the Nissan Leaf, and PHEVs (Plug-in Hybrid Electric Vehicles) for example Toyota Prius. Table 1 represents a comparison between the basic three types of electric vehicles [3].

Table 1. Comparison between EVs

Type	BEV (EV)	HEV	PHEV
Main Power Source	Battery	Combustion engine	Battery
Secondary Power Source	None	Battery	Combustion generator
Source of Battery Charging	Grid power Regenerative brakes	Regenerative brakes	Grid power Regenerative brakes Combustion generator

From the previous comparison, it's obvious that the EVs are the best option for the world future transportation system from the practical point of view and the environmental point of view. This research studies the effect of the higher wind energy contribution on the power system frequency. In addition, it studies the impact of using the EVs as smart energy storage systems in the smart grids and how such systems can deal with the intermittent wind speed in the presence of the genetic algorithm (GA) based PID controller. These points are clarified through making a comparison between five main case studies in the next sections [3].

2. Basic Case Studies

The five main case studies in this work are discussed separately in the next sections, then all case studies will be compared together to clarify the effect of the intermittent wind speed on the power system frequency and how the EVs can mitigate the effect of the wind speed variation on the power system frequency in the presence of the genetic algorithm (GA) based PID controller.

Thermal Power Plant Feeding a Variable Load (Reference Case 1).

In this case, the conventional power system consists of a thermal power plant feeding a changeable load as presented in Fig. 1. This case is considered as the reference case and all other case studies will be referred to it as an evaluation of their responses.

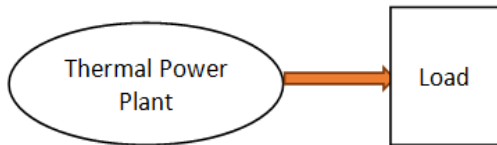

Fig. 1. General layout of conventional power system.

The variable load, the thermal plant power, and the power system frequency responses are clarified in Fig. 2.

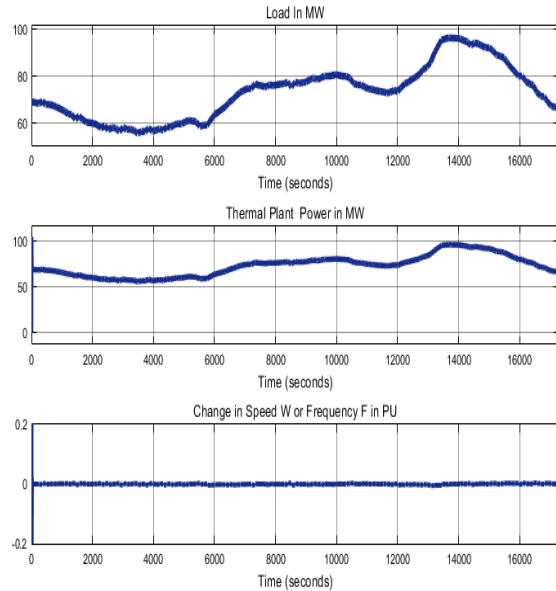

Fig. 2. Results of the first case study.

Thermal Power Plant with Five Wind Power Units Feeding a Variable Load (Case Study 2).

As described in Fig.3, five wind turbine units are used with the thermal power plant to feed the variable load.

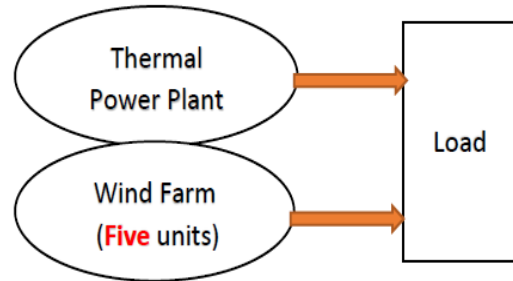

Fig. 3. General layout of the proposed power system for the second case.

The variable load, the thermal plant power, the wind power, and the system frequency responses are illustrated in Fig. 4.

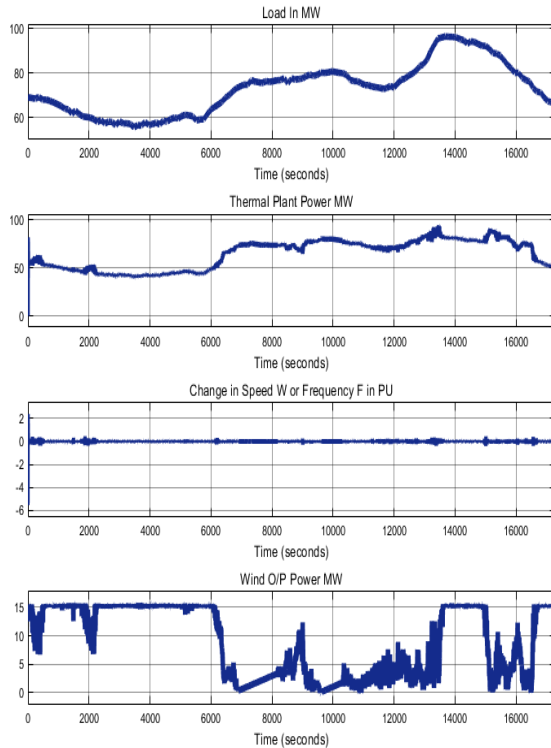

Fig. 4. Results of the second case study.

From the results, it's obvious that due to the wind power, there is fluctuation in the power system frequency, this oscillation increases as the contributions of the wind power increase into the power system [1].

Thermal Power Plant with Ten Wind Power Units Feeding a Variable Load (Case Study 3).

Following is the same as the previous case study, but with more wind energy contribution into the power system as described in Fig. 5.

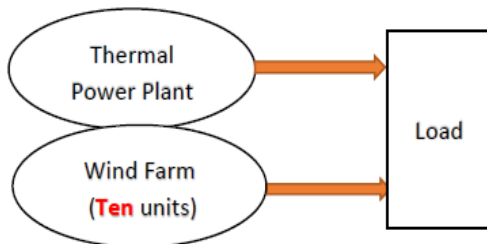

Fig. 5. General layout of the proposed power system for the third case.

The different results, in this case, are presented in Fig. 6 as the third case study of this research, the variable load, the thermal plant power, the wind farm power, and the power system frequency responses are included.

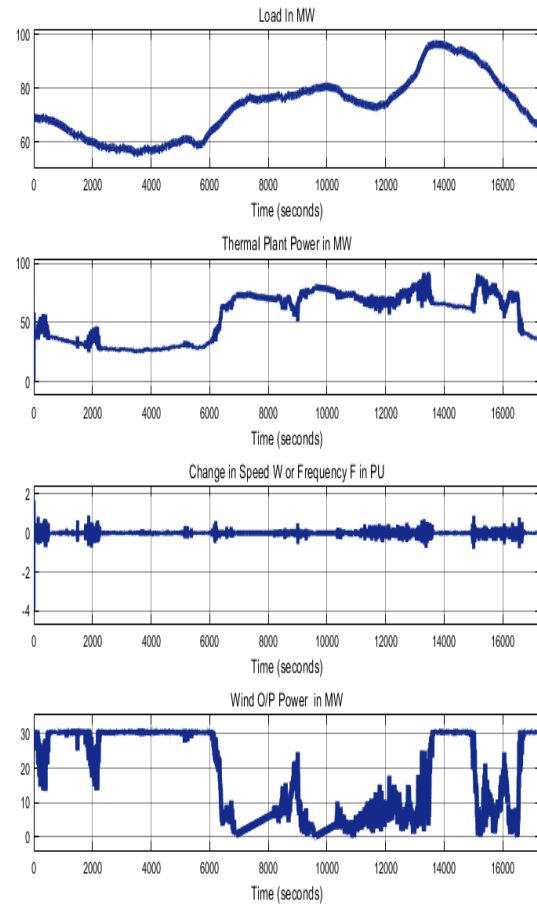

Fig. 6. Results of the third case study.

Thermal Power Plant with Twenty Wind Power Units Feeding a Variable Load (Case 4)

The effect of the higher wind energy penetration on the power system frequency is still discussed in this section, and for this aim, twenty-wind turbine units are used to feed the variable load beside the conventional thermal power plant as clarified in Fig. 7.

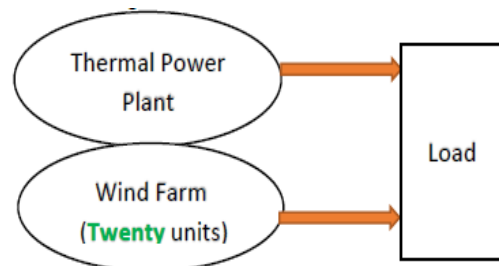

Fig. 7. General layout of the proposed power system in the fourth case.

The power system frequency response is illustrated in Fig. 8.

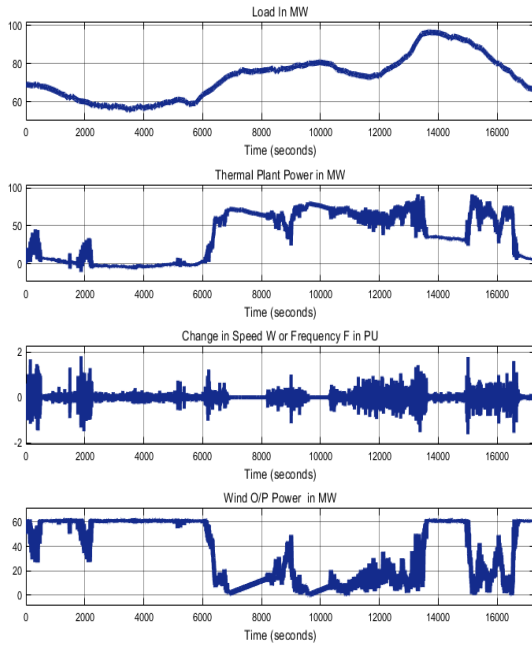

Fig. 8. Results of the fourth case study.

As noticed from the results, the more contribution of the wind energy, the more oscillation on the power system frequency, so different technologies are being used nowadays to smoothen the power system frequency during the wind speed fluctuations and to enhance the contribution of the renewable energy resources into the smart grids as discussed in the introduction. In the next case study Fig. 9, one of the most reputable technologies nowadays is provided when using the genetic algorithm (GA) based PID controller [1].

Thermal Power Plant with Twenty Wind Power Units and EVs Feeding a Variable Load (Case Study 5)

Fig. 9 describes the general layout of the proposed system with the desired future technology EVs.

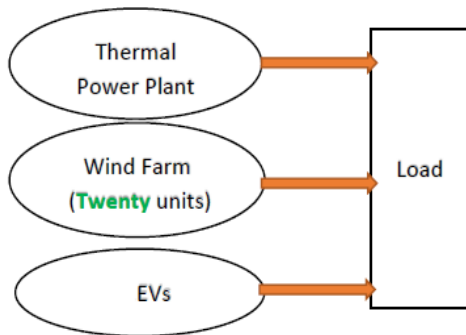

Fig. 9. General layout of the proposed system in the fifth case.

A zoomed view of the EVs response is shown in Fig. 10. The system frequency, the wind power, the conventional thermal power plant power, the EVs contribution, and the variable load are illustrated in Fig. 10 and Fig. 11.

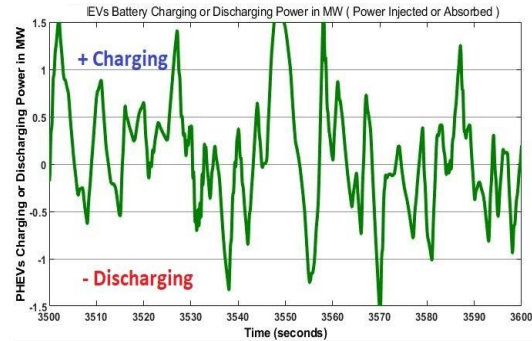

Fig. 10. Zoomed view of the EVs response.

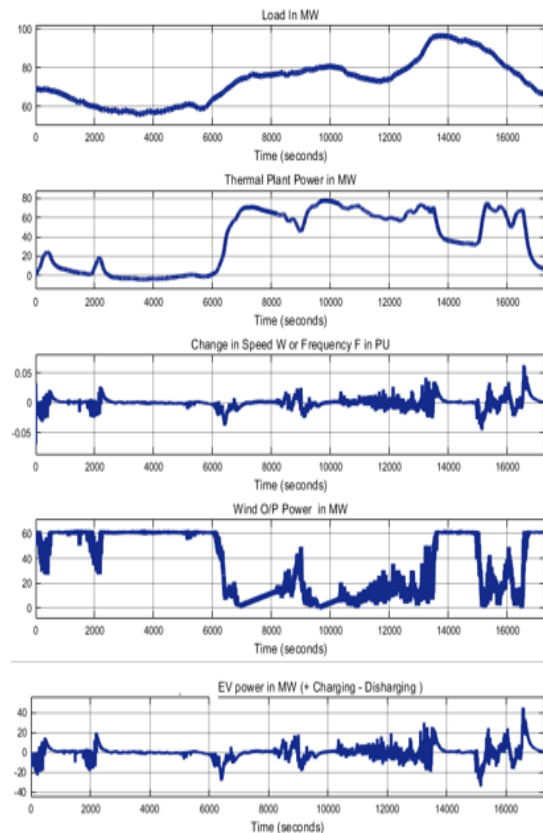

Fig. 11. Results of the fifth case study.

As illustrated in the results, the EVs present a lot of potential in supporting power systems with a high contribution of wind energy, since they can act as a quick response generator source in the vehicle to grid mode and vice versa, since they can act as a demand or load in the grid to vehicle mode [4].

3. Comparison Between the Five Case Studies

After studying each case individually, a fruitful comparison is provided in this section to show how effective is the EVs in smoothing the power system frequency during the wind speed fluctuations when using the genetic algorithm (GA) based PID (proportional-integral-derivative) controller. Fig. 12 represents the frequency response for the five case studies.

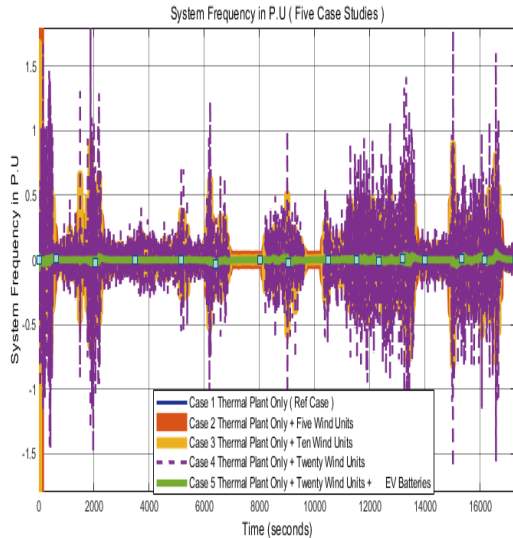

Fig. 12. Comparison between the frequency responses of the five cases.

For more clarification, a small-time range is taken from the previous curve to show the comparison between the frequency responses of the five case studies as presented in Fig. 13.

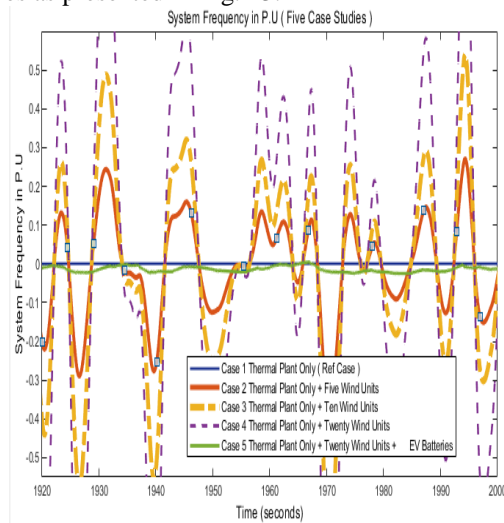

Fig. 13. Zoomed view of the frequency response of the five cases.

Conclusion

As noticed from the results, the more contribution of the wind energy, the more oscillation on the power system frequency, so different technologies are being used nowadays to smoothen the power system frequency during the wind speed fluctuations and to enhance the integration of the renewable energy resources into the smart grids. In this paper, an advanced controller has been designed to improve the frequency response and to compensate the delay in the system when using the EVs in a high wind energy penetration power system.

The designed controller was a genetic algorithm (GA) based PID (proportional-integral-derivative) controller, it has been proposed for tuning optimized PID parameters and it was very effective. The EVs have been used as a smart energy storage system to support the integration of the high wind energy into the power system in the presence of the genetic algorithm based PID controller.

The EVs could act as a very fast response storage system. As far as future work is concerned, although power loss is not yet considered in this stage, it will be considered with the view to further enhancement of the system's efficiency. Moreover, future work will explore the possibilities of using a hierarchical framework to coordinate the centralized control base with a decentralized controller in each individual vehicle.

In this paper, the EVs have been used to support the more contribution of the wind energy into the power system. EVs can act as a very fast response generator source in vehicle to grid mode and vice versa since they can act as a demand or load in the grid.

References

1. Vachirasricirikul, S. and Ngamroo, I., 2014. Robust LFC in a Smart Grid With Wind Power Penetration by Coordinated V2G Control and Frequency Controller. *IEEE Transactions on Smart Grid*, 1(5), pp.371-380.
2. M. E. Khodayar, L. Wu, and M. Shahidehpour, "Hourly coordination of electric vehicle operation and volatile wind power generation in SCUC," *IEEE Trans. Smart Grid*, vol. 3, no. 3, pp. 1271-1279, Sep. 2012.
3. Mi, C. and Masrur, M.A., 2017. Hybrid electric vehicles: principles and applications with practical perspectives. John Wiley & Sons.
4. Guille, C. and Gross, G., 2010, August. The integration of PHEV aggregations into a power system with wind resources. In *Bulk Power System Dynamics and Control (iREP)- VIII (iREP)*, 2010 iREP (pp. 1-9). IEEE.

5. Tan N. Le^{1;2}, Saba Al-Rubaye¹, and Bong Jun Choi. Dynamic Charging and Discharging for Electric Vehicles in Microgrids. IEEE ICC2015-Workshop on Green Communication and Networks with Energy Harvesting. Smart Grid and Renewable Energies. 2015.
6. Zhao, H., Wu, Q., Hu, S., Xu, H. and Rasmussen, C.N., 2015. Review of energy storage system for wind power integration support. Applied Energy, 137, pp. 545-553.
7. A. Saber and G. Venayagamoorthy, "Resource scheduling Under uncertainty in a smart grid with renewables and plug-in vehicles," Systems Journal, IEEE, vol. 6, no. 1, pp. 103–109, March 2012.
8. Mahmoud, A.M., Othman, and Abdelaziz, A.Y., 2017, December. A comprehensive approach for energy storage systems optimal planning and operation in presence of wind power generation. In Power Systems (MEPCON), 2017 Nineteenth International Middle East (pp. 377-384). IEEE.
9. Aghaei, J., Nezhad, A.E., 2016. Contribution of plug- in hybrid electric vehicles in power system uncertainty management. Renewable and Sustainable Energy Reviews, 59, pp.450-458.

10/25/2018