



## Effect of subsurface drip irrigation on water productivity and yield of sugarcane in southwest of Iran

Ali Sheini Dashtegol

Department of irrigation and drainage, Shahid Chamran University of Ahvaz, Ahvaz, Iran  
[alidashtegol99@gmail.com](mailto:alidashtegol99@gmail.com)

**Abstract:** One of the most important limiting factors for sugarcane irrigation in Khuzestan is the high temperature and evaporation in the warm seasons and low quality of irrigation water. Therefore, in order to investigate the effect of 15, 20 and 30 cm depths and 50, 60 and 75 cm distances of subsurface drippers on water productivity and quantitative and qualitative yield of sugarcane CP69- 1062 cultivars, a factorial design in form of randomized complete block design was carried out at the sugarcane Research and training Institute of Khuzestan in South-West of Iran. The ANOVA results showed that there are significant differences between treatments in terms of distances and depths and their interactions. The results of statistical analysis of qualitative traits showed that, in most traits, the experimental treatments had a significant difference in the distance between drippers at 1% probability level. Investigating the water productivity index for sugar cane and sugar production showed that the treatments were meaningful in terms of the distance between drippers at 1% probability level, but in terms of depth and the interactions of distance and depth, there is no significant difference between them. The highest performances were at 50 and 20 cm distance and depth respectively. The highest water productivity was at 60 cm distance and of 15 cm depth of drippers. At 60 cm distance, 20 and 15 cm depth of drippers, the highest water productivity was obtained for sugarcane and produced sugar, which was 7.18 kg/m<sup>3</sup> and 387 kg/m<sup>3</sup> respectively. In general, according to the results and expert studies, the 20 cm depth of the dripper and 50 cm distance are proposed for drippers. with increasing evaporation in warm days and long irrigation duration, two liters per hour rate of drippers can be suitable. [Sheini Dashtegol, A. **Effect of subsurface drip irrigation on water productivity and yield of sugarcane in southwest of Iran.** *Nat Sci* 2020;18(8):45-55]. ISSN 1545-0740 (print); ISSN 2375-7167 (online). <http://www.sciencepub.net/nature>. 7. doi:[10.7537/marsnsj180820.07](https://doi.org/10.7537/marsnsj180820.07).

**Keywords:** sugarcane; subsurface drip irrigation; pressure controlled emitters; water productivity; quality and quantity Characteristics.

### 1. Introduction

Sugarcane fields of south west of Iran have heavy soil texture, high temperatures, hot and dry wind flow at spring and summer seasons. Hydroflume gated pipes were used for irrigation. Furrow irrigation were used in sugarcane fields. EC of irrigation water was considered about 1.1 ds/m, in basic designs of this irrigation method (anonymous, 1991). In addition to the sugarcane production, sugar is a basic good in economic section of Iran and have multiple use in food, medical and chemical industry, production of by products such as feedstuffs, yeast and alcohol, wood and paper. Sugarcane require lot of water during the growing period and sensitive to water stress and although no compatible to long duration flooding. If ground water rises and cover root zone, crop yield decreases due to root rot (Sheini-dashteghol et al. 2009). Sugarcane is a hydrophyte plant but so sensitive to ponded conditions (Abbasi and Sheini-dashteghol, 2016).

Drip is an irrigation technology known to increase the control of water application and offers several advantages to growers. It reduces soil

evaporation and weed population, increases plant transpiration, and when well-managed, excessive water drainage is occur, thus allowing nutrients to be retained in the root zone for prolonged periods (Burt. 1998; Goldberg et al. 1976; Lamm et al. 2011). Subsurface drip irrigation (SDI) is an advanced irrigation system that minimizes the water losses by evapotranspiration from soil and weeds and by soil drainage below the root system. SDI has been successfully tested on several crops under Mediterranean conditions (Ayars et al. 1999, 2015). SDI can result in an increase of the agronomic water-use efficiency (WUE), the ratio of crop yield to total water consumption, when compared with other irrigation systems (Najafi and Tabatabaei. 2007). Compared to other irrigation methods, drip irrigation systems provide the possibility to apply lower volumes of water, more frequently and efficiently. If well designed, these systems make it possible to apply slow, steady and uniform amounts of water and nutrients within the plant's root zone, while

minimizing deep percolation and maintaining high productivity levels (Rallo et al. 2011). The main advantages of SDI are related to water savings because water is applied directly to the crop's root zone, which prevents losses due to direct evaporation from the soil and deep drainage, and, if properly managed, SDI allows for the maintenance of appropriate levels of soil moisture (Camp. 1998; Lamm and Trooien. 2003; Lamm and Camp. 2007). Lamm et al. (1995) showed that subsurface drip cultivation reduces the amount of water required for irrigation by 25%. Furthermore, another advantage of SDI is related to more efficient fertigation due to improved water application uniformity (Gil et al. 2008).

Martínez-Gimeno et al. (2018) assessed the performance of a citrus crop under surface and subsurface drip irrigation. They reveal that on average, water savings were 23.0% in the subsurface drip irrigation treatment compared to the surface irrigation treatment without significant differences in either yield or fruit composition.

Çolak et al. (2018) evaluated response of yield and quality to various irrigation regimes applied with subsurface drip irrigation and surface drip irrigation systems on eggplant and net profit generation in the Mediterranean Region of Turkey. Surface drip and subsurface drip systems were tested in a split plot design. Subsurface drip irrigation used slightly less water than the surface drip plots due to reduced evaporation losses from the soil surface and irrigation systems, intervals and regimes resulted in significantly different yields and quality.

N.S.dos Santos et al. (2016) evaluated water storage in the soil profile when using a subsurface drip irrigation system at two dripper installation depths (0.20 or 0.40 m) and two water qualities (treated sewage effluent (TSE) and freshwater) in two crop cycles of sugarcane in Campinas SP (Brazil). They resulted that installation of a 0.2 m drip tube proved to be an ideal solution for both environmental management and water use efficiency when using treated sewage effluent and for management of subsurface drip irrigation by the water balance in the soil, different layers in the soil profile should be considered to calculate the water depth, using the depth of the drip tube installation as a reference.

Reyes-Cabrera et al. (2016) evaluated irrigation water use efficiency (WUE) for potatoes and soil moisture distribution uniformity for two drip tape installation depths (surface at 0.05 m and subsurface at 0.15 m depth) as an alternative method to seepage irrigation. By measuring the volume of water, water table, and soil volumetric water content for two seasons, 2011 and 2012, they resulted that drip irrigation reduced water use 48% and 88% in 2011

and 2012, respectively, Higher WUE was obtained with drip compared to seepage irrigation for all varieties in 2012.

Pires et al. (2014) studied the evaluation of subsurface drip irrigation and sugarcane spacing on stem yields, sugarcane technological quality, and the theoretical recoverable sugar yields during four cycles of sugarcane cultivation. Thus, irrigation increased stem yields in the ratoon cane cycles and that the theoretical recoverable sugar yields increased in the last two ratoon cane cycles. According to the row spacing, double row planting produced the greatest stem yields and theoretical recoverable yields in the plant cane cycle and the second ratoon cane cycle and resulted the benefits to sugarcane properties of subsurface drip irrigation over the four years of this research.

Due to water crisis in Iran, this study aimed to reduce volume of consumed water for sugar production by managing water consumption in the form of drip irrigation for the first time in cultivation of sugarcane.

## 2. Material and Methods

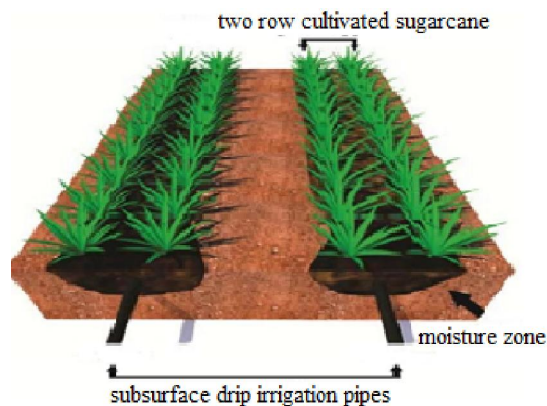

Figure 1. Located subsurface drip irrigation tubes

This experience was in sugarcane research and training institute which located in south west of Iran. Field experiment area was 1.2 ha which had 27 furrows which lengthen 238m. The experiment field is located in warm and dry weather region at 48 degrees and 33 minutes east longitude and 30 degrees and 59 minutes north latitude and 725.5 meter height. Field preparation steps for cultivating sugarcane, including deep plowing, disk discs to crush the husk, trowel, grooving (furrow preparation) and fertilizer operations (Triple superphosphate 250 kg ha<sup>-1</sup>) before cultivation and after selecting the cultivar (cultivar CP69-1062 due to the commercial cultivar of the area), the cuttings were cultivated in a double row with 40 centimeters row spacing and handed straight to the

stack. The tubes were placed in the middle of two rows of cultivators by means of a piping machine. In Figure (1), the two-row planting and the location of the dripper tubes are shown.

Before cultivating, soil samples were collected from experiment field at 0-30, 30-60 and 60-90 cm depths. Soil sampling and soil analysis (EC, pH, cations and Anions, texture and bulk density). In order to measure the bulk density of soil, samples were collected from the undistributed samples with sampler cylinders and the texture was determined by hydrometer method (Silt Clay Loam). In depth, electric conductivity of soil decreasing and acidity has

increased. Soil bulk density have increased in depth which indicated a higher density of soil at lower depths. Sodium adsorption ratio (SAR) from the surface to depth has decreased and is subject to changes in the amount of sodium, so that the soil is sodic-saline in the surface layer and in lower layers. To determine soil moisture percentage content in field capacity (FC) and permanent wilting point (PWP), pressure plate was used (and the results were 25.1% and 12.9% respectively). The results of some physicochemical properties of soil before the experiment are presented in Table (I).

Table I. physic- chemical soil characteristic of experimental field

| depth (cm) | EC (ds/m) | pH   | $\rho_b$ (gr/cm <sup>3</sup> ) | soil texture | cation (meq/l)  |                  | SAR              |                |       |
|------------|-----------|------|--------------------------------|--------------|-----------------|------------------|------------------|----------------|-------|
|            |           |      |                                |              | Na <sup>+</sup> | Ca <sup>2+</sup> | Mg <sup>2+</sup> | K <sup>+</sup> |       |
| 0-30       | 6.97      | 7.19 | 1.5                            | Si.C.L       | 51.3            | 11.09            | 11.52            | 0.18           | 15.3  |
| 30-60      | 4.75      | 7.28 | 1.57                           | Si.C.L       | 35.6            | 7.82             | 8.04             | 0.12           | 12.64 |
| 60-90      | 4.73      | 7.29 | 1.61                           | Si.C.L       | 32.4            | 9.89             | 10.82            | 0.01           | 10.07 |

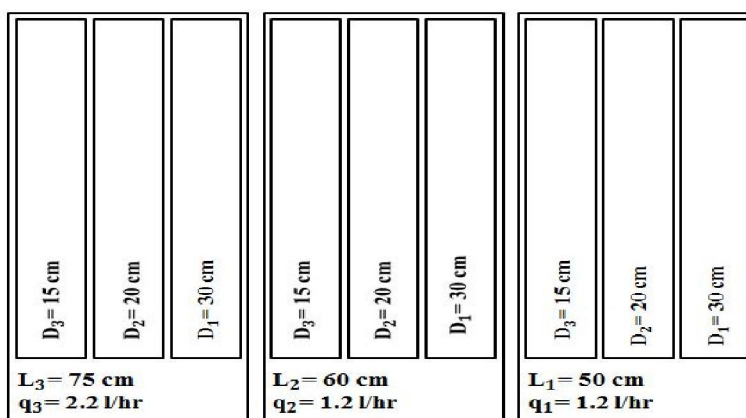

Figure 2. Schematic of different experimental treatments

The experiments were carried out in a complete randomized block design with a factorial arrangement in both the depth and distance of the drippers. The treatments were arranged from the combination of three drippers spacing on a dripper pipe and three dripper placement depths as shown in Figure 2. The dripper pipes bought from sunstream company which drippers are Pressure controlled dripper type, anti syphone (PC, AS) and the pressure at the pump station is 43 m, and drippers With a flow rate of 1.2 and 2.1 liters per hour, the dripper distance on the tubes are 50 and 60 cm (for a discharge rate of 1.2 liters per hour) and 75 centimeters (for discharge outlet droplets, 2. 2

liters per hour) and the depth of drippers pipes were 15, 20 and 30 cm from the surface soil. Water resource was from the Karun River, which was transported by means of a pumping station to the farm, and the design of the pumping and filtration station was carried out with a preliminary analysis of irrigation water and TSS of 115 mg / l and a sedimentation pond was constructed to inject acid, chlorine and fertilizer. Results of the average analysis for irrigation water during plant period and the average 20 years climate statistics of the study region are shown in tables (II) and (III).

Table II. Karoon river irrigation water quality for sugarcane (September 2016 to December 2017)

| EC (dS/m) |         | pH   |       | TDS (mg/l) |           | TH (mg/l) |         | (mg/l) Ave. cation |                  |                  | SAR | Class |
|-----------|---------|------|-------|------------|-----------|-----------|---------|--------------------|------------------|------------------|-----|-------|
| Ave.      | range   | Ave. | range | Ave.       | range     | Ave.      | range   | Na <sup>+</sup>    | Ca <sup>2+</sup> | Mg <sup>2+</sup> |     |       |
| 2.2       | 1.6-2.8 | 7.5  | 7-8.2 | 1560       | 1100-2042 | 603       | 325-865 | 14.8               | 5.3              | 6.9              | 6   | C3s2  |

Table III. 20 year average of meteorology parameters (1998-2018)

| total average temperature (°C) | Total average humidity (%) | max absolute temperature (°C) | min absolute temperature (°C) | average yearly precipitation | average yearly evaporation (mm) | max daily evaporation (mm) | wind Speed (m/s) | wind direction |
|--------------------------------|----------------------------|-------------------------------|-------------------------------|------------------------------|---------------------------------|----------------------------|------------------|----------------|
| 25.1                           | 44.6                       | 51.5*                         | 4.5**                         | 157                          | 3218                            | 28.2***                    | 2.4              | NW             |

\*this is happened in June 1999 \*\* this is happened in February 2011 \*\*\* this is happened in June 2006

For measuring Soil moisture in the root zone during growth, sampling, soil acidity, electrolytic conductivity of the soil around the drippers and performing crop log operations (stem height, water table, nitrogen, leaf area index and leaf moisture content were measured weekly) were measured in the growth duration. In order to control the soil moisture content in sugarcane growth period, a number of moisture probes were installed in the field and by using time domain reflectometry (TDR), moisture content of the drippers and its distribution were controlled. Depending on the number of irrigation and

irrigation water acidity, acid was injected into the irrigation water to prevent clogging of the drippers, and after a certain period of time it was discharged from the network. Regarding the presence of algae in irrigation water, glycolic acid was used in acid filtration before irrigation and in field capacity. The schematic pumping and filtration station is shown in Figure 3, the schematic of the subsurface drip irrigation system in Figure 4. Figure 5 shows Pumping and filtration station and observation the subsurface drip irrigation farm.

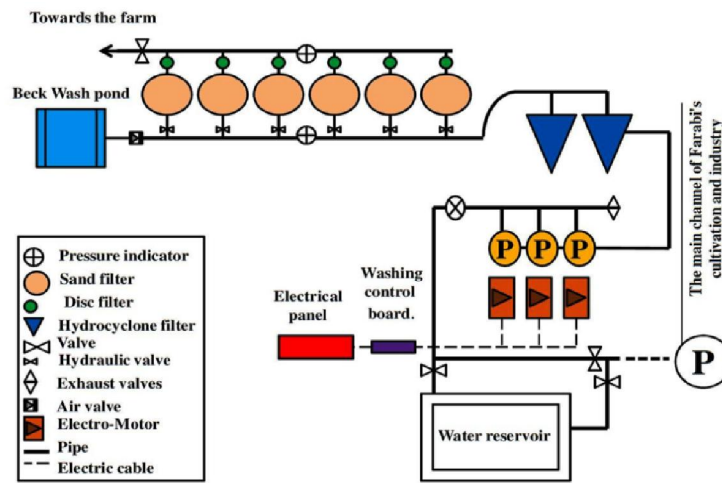

Figure 3. Schematic of pumping and filtration station in subsurface drip irrigation system

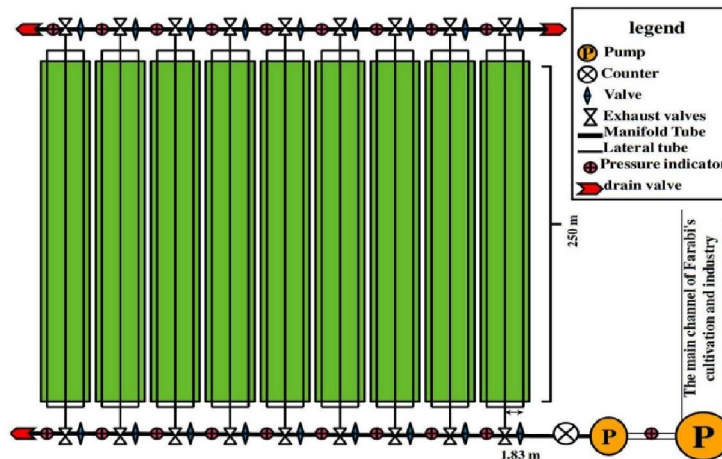

Figure 4. Schematic subsurface drip irrigation system





Figure 5. Pumping and filtration station and observation the subsurface drip irrigation farm

According to the design calculations, irrigation intervals in the peak period is calculated daily and in other periods calculated from equation 1 and 2:

$$I = d_n / ET_c \quad (1)$$

$$ET_c = ET_0 \times K_c \quad (2)$$

I: maximum irrigation period;

$d_n$ : irrigation requirement;

$ET_c$ : real evapotranspiration of sugarcane;

$ET_0$ : reference evapotranspiration which calculated by Meteorology data (Allen et al. 1998)

$K_c$ : sugarcane crop coefficient which determined by lysimeter.

Irrigation is based on sugarcane allowable depletion and irrigation period (Pires et al. 2014)

Net irrigation depth, Irrigation gross depth, leaching fraction and irrigation volume are calculated by equation 3 to 7:

$$d_n = (\theta_{fc} - \theta_{pwp}) \times D_{rz} \times \rho_b \times MAD \quad (3)$$

$d_n$ : net irrigation depth (mm)

$\theta_{fc}$ : volumetric moisture in field capacity (%)

$\theta_{pwp}$ : volumetric moisture in permanent wilting point (%)

$D_{rz}$ : root depth (mm)

$\rho_b$ : soil bulk density ( $gr.cm^{-3}$ )

MAD: management allowed depletion (%)

In subsurface irrigation, wetted area percentage ( $P_w$ ) is considered and modified equation is ( equation (4)):

$$d_n = (\theta_{fc} - \theta_{pwp}) \times D_{rz} \times \rho_b \times MAD \times P_w \quad (4)$$

Gross irrigation depth is calculated from equation 5:

$$d_g = \frac{d_n}{(1-LF) \times E_a} \quad (5)$$

$d_g$ : gross irrigation depth (mm);

$d_n$ : net irrigation depth (mm);

$E_a$ : irrigation efficiency (%);

LF: leaching fraction (%) which calculated by equation (6):

$$LF = \frac{EC_{iw}}{2 EC_{e\max}} \quad (6)$$

$EC_{iw}$ : electric conductivity of irrigation water (ds/m)

$EC_{e\max}$ : electric conductivity of saturated soil juice (ds/m)

$$V_g = d_g \times A \times Ps \quad (7)$$

$V_g$ : gross volumetric water requirement (lit);  
 $d_g$ : gross water depth (mm);  
 $A$ : plot area ( $m^2$ );  
 $Ps$ : wetted percentage (%) (Anonymous. 2014);

After irrigation and drought stress, the process of cane treatment started. 20 cane randomly selected from each treatment on a weekly basis. The quality of juice is measured until the process of completion is completed and then the harvest is carried out. Bull (1971) resulted that under drought stress and end of growing season, due to water crisis less sucrose produced but at the end sugar content of sugarcane increases. In this experiment three repetitions of each experimental treatment were selected and the number of tillers was counted and 20 stems were weighted, stem density, total yield, yield of sugarcane ( $t \cdot ha^{-1}$ ) and tiller number per hectare were measured and after yield was determined, water productivity (yield ratio on volume of intake) calculated based on the volume of water consumed during the growth period of sugarcane (irrigation and rainfall). Also in each treatment in three length repetitions, 60 stem were

selected randomly, weight and height of stems were measured and quality factors were measured at the lab. These operations were performed for surface irrigation too. After cane extraction, for determining sugarcane quality factors, sucrose content in the juice (Polarization measurement) and soluble solid particles in cane juice (Brix) were measured. POL content was measured by Saccharimeter and by applying POL number modified coefficient from related tables, the real POL number is calculated. Brix was measured by Refractometer. By dividing POL in Brix juice purity (PTY) is calculated. Quality Ratio (Q.R) is calculated from equation (10) which P.F is purity percentage modification coefficient and extracted from related tables. Yield (Y), Recovery Sugar (R.S) and Sugar Yield (S.Y) are calculated from equation 11 to 13(whalley 1964):

$$S.R \times \text{Pool Factor POL} = \% \quad (8)$$

$$Q.R = \frac{P.F}{Pol} \quad (9)$$

$$\text{Yield} = \frac{100}{Q.R} \quad (10)$$

$$R.S = \text{Yield} \times 0.83 \quad (11)$$

$$S.Y = Y \times R.S \quad (12)$$

Finally, the average of quantitative and qualitative functions and water productivity in subsurface drip irrigation was compared with surface irrigation. For data fitting and curves, EXCEL software, SAS statistical software was used for statistical analysis.

### 3. Results

Table IV showed average interaction of distance and depth of drippers for different quantities of the crop.

Table IV. Average interaction of distance and depth of drippers for different quantities of the crop

| parameter                | degree of freedom | sugarcane productivity (ton/ha) | number of tiller (ha) | height of stem (cm) | of water productivity for sugar ( $kg/m^3$ ) | water productivity for sugarcane ( $kg/m^3$ ) |
|--------------------------|-------------------|---------------------------------|-----------------------|---------------------|--|---|
| iteration                | 3                 | 81.7 <sup>n.s</sup>             | 36871811 **           | 4.34*               | 0.044**                                      | 0.024 <sup>n.s</sup>                          |
| distance                 | 2                 | 540.7 **                        | 998639860 **          | 44.78 **            | 0.12 **                                      | 7.59 **                                       |
| depth                    | 2                 | 58.92 **                        | 74084178 **           | 727.11 **           | 0.0022 **                                    | 0.15**  |
| interaction              | 4                 | 46.48 **                        | 277592773 **          | 583.22 **           | 0.00026 <sup>n.s</sup>                       | 0.11 **                                       |
| error                    | 16                | 3.43                            | 5211093               | 4.67                | 0.0001                                       | 0.011   |
| coefficient of variation |                   | 1.53                            | 1.31                  | 1.07                | 1.7  | 1.63  |

In table IV experiment treatments have significant difference in 1% probability level. Water productivity of produced sugarcane and sugar show that experimental treatments have significance difference in distance of drippers but depth of drippers

and interaction of distance and depth of drippers have no significance difference.

Table V shows mean variance analysis of interaction for distance and depth of drippers for different qualities of the crop.

Table V. Average interaction of distance and depth of drippers for different qualities of the crop

| parameter                | degree of freedom | soluble particles of juice | solid of cane juice | sucrose percentage cane juice | purity of percentage cane juice | sugar of percentage | sugar productivity (ton/ha) |
|--------------------------|-------------------|----------------------------|---------------------|-------------------------------|---------------------------------|---------------------|-----------------------------|
| iteration                | 3                 | 5.58 **                    |                     | 0.61 <sup>n.s</sup>           | 9.6 **                          | 9 **                | 15.4 **                     |
| distance                 | 2                 | 5.05 **                    |                     | 1.89 <sup>n.s</sup>           | 0.6 **                          | 0.84 **             | 3.05 **                     |
| depth                    | 2                 | 0.63 *                     |                     | 0.13 <sup>n.s</sup>           | 0.72 **                         | 0.07 **             | 0.83 **                     |
| interaction              | 4                 | 0.88 **                    |                     | 0.318 <sup>n.s</sup>          | 0.18 <sup>n.s</sup>             | 0.164 **            | 0.103 <sup>n.s</sup>        |
| error                    | 16                | 0.15                       |                     | 0.49                          | 0.84                            | 0.00                | 0.052                       |
| coefficient of variation |                   | 1.8                        |                     | 3.69                          | 0.3                             | 0.14                | 1.62                        |

Table V reveals that all treatments have significant difference at 1% probability level comparing with distance of drippers, except sucrose percentage of cane juice. Depth of drippers have significance difference at 5% probability level for soluble solid particles of cane juice, purity percentage of cane juice and sugar percentage have significance difference at 1% probability level. Sucrose percentage of cane juice did not have significant difference comparing with distance and depth of drippers and interaction of them. But sugar productivity have significant difference at 1% probability level comparing with distance of drippers and have no significant difference comparing with depth of drippers and interaction of both depth and distance of drippers.

Results of mean Square variance analysis sugarcane quantities (table VI) shows that the highest sugarcane productivities were in 50cm distance and 15cm, 20cm depth of drippers (were in one group and have no significant difference) and this group have significant difference with 30cm depth of drippers. Also highest stem density was in 50cm distance of drippers and 20cm depth of drippers which have no significant difference with 15cm and 30cm depth of drippers. The highest productivity of Brix, POL and RS were in 60cm distance and 15cm depth of drippers which have significant difference with other depths. Highest PTY productivity was in 50cm distance and 15cm, 20cm depth of drippers and have significant difference with other depths.

Table VI. Mean Square variance analysis of quality and quantity characteristics of sugarcane

| treatment                    |                 | quantity characteristic |                        |                        | quality characteristic     |                     |                   |                   | sugar productivity |          |
|------------------------------|-----------------|-------------------------|------------------------|------------------------|----------------------------|---------------------|-------------------|-------------------|--------------------|----------|
| distance (cm)                | depth (cm)      | stem height (cm)        | number of stem hectare | of pure (in of ton/ha) | productivity sugarcane (%) | Brix (%)            | Pol (%)           | PTY (%)           | RS (%)             | (ton/ha) |
| L <sub>50</sub>              | D <sub>30</sub> | 179 <sup>d</sup>        | 184601 <sup>b</sup>    | 123 <sup>b</sup>       | 21.73 <sup>ab</sup>        | 18.9 <sup>ab</sup>  | 87 <sup>b</sup>   | 11.6 <sup>d</sup> | 14.27 <sup>a</sup> |          |
|                              | D <sub>20</sub> | 202 <sup>c</sup>        | 191333 <sup>a</sup>    | 134 <sup>a</sup>       | 20.13 <sup>c</sup>         | 18.3 <sup>b</sup>   | 90 <sup>a</sup>   | 11.1 <sup>f</sup> | 14.87 <sup>b</sup> |          |
|                              | D <sub>15</sub> | 210 <sup>b</sup>        | 178599 <sup>c</sup>    | 132 <sup>a</sup>       | 20.53 <sup>b</sup>         | 18.6 <sup>ab</sup>  | 90.7 <sup>a</sup> | 11.5 <sup>e</sup> | 15.18 <sup>b</sup> |          |
| L <sub>60</sub>              | D <sub>30</sub> | 190 <sup>e</sup>        | 184002 <sup>b</sup>    | 113 <sup>d</sup>       | 22.2 <sup>ab</sup>         | 19.46 <sup>a</sup>  | 87.8 <sup>b</sup> | 12 <sup>b</sup>   | 13.56 <sup>a</sup> |          |
|                              | D <sub>20</sub> | 181 <sup>f</sup>        | 170020 <sup>d</sup>    | 116 <sup>d</sup>       | 22.2 <sup>ab</sup>         | 19.2 <sup>ab</sup>  | 86.9 <sup>b</sup> | 11.8 <sup>c</sup> | 13.69 <sup>a</sup> |          |
|                              | D <sub>15</sub> | 225 <sup>a</sup>        | 163623 <sup>c</sup>    | 115 <sup>d</sup>       | 22.5 <sup>a</sup>          | 19.67 <sup>a</sup>  | 87.7 <sup>b</sup> | 12.2 <sup>a</sup> | 14.03 <sup>b</sup> |          |
| L <sub>75</sub>              | D <sub>30</sub> | 195 <sup>d</sup>        | 162366 <sup>c</sup>    | 117 <sup>c</sup>       | 21.8 <sup>ab</sup>         | 18.67 <sup>ab</sup> | 86.9 <sup>b</sup> | 11.5 <sup>e</sup> | 13.46 <sup>a</sup> |          |
|                              | D <sub>20</sub> | 209 <sup>b</sup>        | 156969 <sup>f</sup>    | 114 <sup>dc</sup>      | 22 <sup>ab</sup>           | 19.1 <sup>ab</sup>  | 86.8 <sup>b</sup> | 11.8 <sup>c</sup> | 13.45 <sup>a</sup> |          |
|                              | D <sub>15</sub> | 198 <sup>d</sup>        | 172310 <sup>d</sup>    | 122 <sup>b</sup>       | 21.5 <sup>b</sup>          | 18.67 <sup>ab</sup> | 87 <sup>b</sup>   | 11.5 <sup>e</sup> | 14.03 <sup>b</sup> |          |
| Surface irrigation (control) |                 | 223                     | 143807                 | 95                     | 22                         | 3.19                | 87                | 12                | 11.4               |          |

Highest stem height was in 60cm distance and 15cm depth of drippers, Leonardo et al (2016); Regina

Célia et al (2015) have the same results. Results of mean square variance analysis for quality

characteristics of sugarcane show that the highest productivity was in 60cm distance and 15cm depth of drippers and have significant difference with other depths. Bull (1971) reveal that under drought condition and stress of the ending growing season, increases amount of sugar and sugarcane tiller quality. Highest productivity of sugar were in 50cm distance and 15cm, 20cm depth of drippers (which were in the same group and have no significant difference) and have significant difference with 30cm depth of drippers. Table VII show that according to designing computations, irrigation water requirement at 50cm

distance of drippers was 18318(m<sup>3</sup>/ha), for 60cm distance irrigation was less than 20% of the water requirement and for 75cm distance irrigation was 16% more than water requirement. Less consuming water lead to high sugarcane quality. Due to less consuming water, water productivity for produced sugar and sugarcane increased. Which in 60cm distance and 20cm, 15cm depth of drippers caused higher water productivity for produced sugarcane and sugar about 7.18 kg/m<sup>3</sup> and 0.87 kg/m<sup>3</sup>, respectively and have no significant difference for other depths

Table VII. Water productivity for produced sugarcane and sugar and volume of consumed water

| treatment         |                 | Volume of consumed water (m <sup>3</sup> /ha) |                |              | water productivity (kg/m <sup>3</sup> ) |                    |
|-------------------|-----------------|---|----------------|--------------|---|--------------------|
| distance          | depth           | irrigation water                              | rainfall water | total volume | for produced sugarcane                  | for produced sugar |
| L <sub>50</sub>   | D <sub>30</sub> | 18318   | 883            | 19201        | 6.41 <sup>ab</sup>                      | 0.74 <sup>ab</sup> |
|                   | D <sub>20</sub> |   |                |              | 6.98 <sup>ab</sup>                      | 0.77 <sup>ab</sup> |
|                   | D <sub>15</sub> |   |                |              | 6.88 <sup>ab</sup>                      | 0.79 <sup>ab</sup> |
| L <sub>60</sub>   | D <sub>30</sub> | 15277   | 883            | 16160        | 6.99 <sup>ab</sup>                      | 0.84 <sup>a</sup>  |
|                   | D <sub>20</sub> |   |                |              | 7.18 <sup>a</sup>                       | 0.85 <sup>a</sup>  |
|                   | D <sub>15</sub> |   |                |              | 7.12 <sup>a</sup>                       | 0.87 <sup>a</sup>  |
| L <sub>75</sub>   | D <sub>30</sub> | 21149   | 883            | 22032        | 5.31 <sup>b</sup>                       | 0.61 <sup>b</sup>  |
|                   | D <sub>20</sub> |   |                |              | 5.17 <sup>b</sup>                       | 0.61 <sup>b</sup>  |
|                   | D <sub>15</sub> |   |                |              | 5.54 <sup>b</sup>                       | 0.64 <sup>b</sup>  |
| Surface (control) | irrigation      | 36000   | 883            | 36883        | 2.58                                    | 0.31               |

Qualitative and quantities characteristic of subsurface drip irrigation and surface irrigation were compared In figures 6 to 11. in surface irrigation average height stem was 22cm higher than subsurface irrigation but due to high tiller density (stem per hectare) in subsurface drip irrigation, sugarcane average productivity was 26 ton/ha less in surface irrigation and both have significant difference. Figure 6 show that in subsurface drip irrigation number of stem per hectare was 30000 (stem /ha) more than surface irrigation system and have significant difference. Sucrose percentage, soluble solid particle, cured sugar percentage and sugarcane juice purity percentage of subsurface drip irrigation and surface irrigation were in same group and have no significant difference. Productivity of cured sugar purity for subsurface drip irrigation was 2.8 ton/ha higher than surface irrigation and have significant difference. Water productivity of produced sugarcane and sugar for subsurface irrigation was 3.84 kg/m<sup>3</sup> and 0.44 kg/m<sup>3</sup> higher than the surface irrigation system and have significant difference.

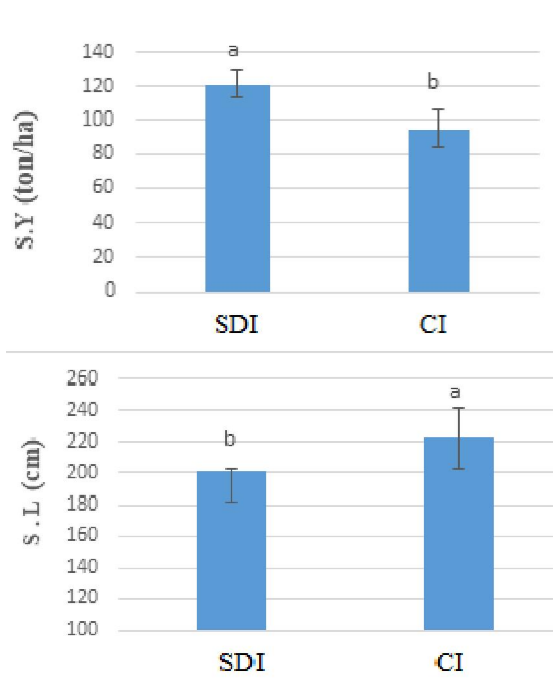

Figure 6. Sugarcane length and sugarcane yield in the subsurface drip irrigation and conventional irrigation



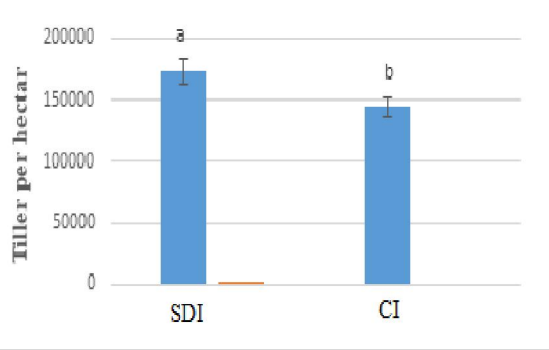

Figure 7. Tiller per hectare in the subsurface drip irrigation and conventional irrigation

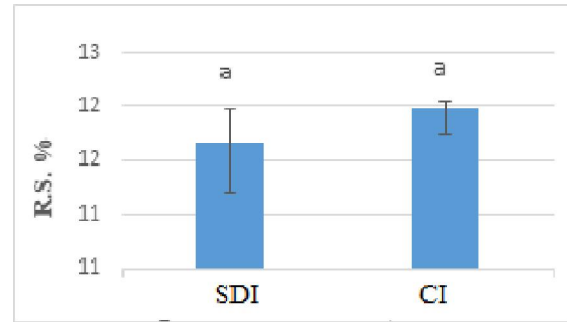

Figure 9. Recovery Sugar and Purity in the subsurface drip irrigation and conventional irrigation

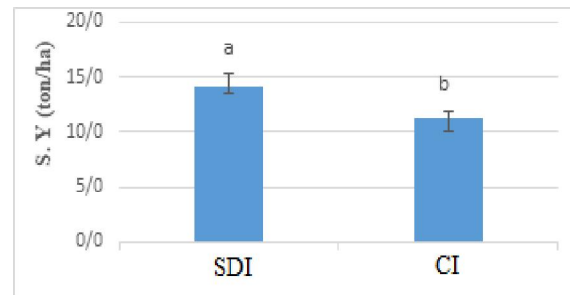
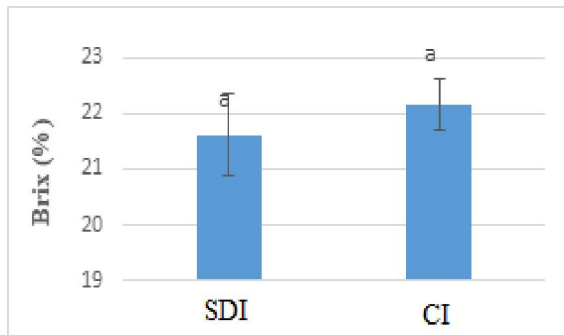

Figure 10. Sugar Yield in the subsurface drip irrigation and conventional irrigation

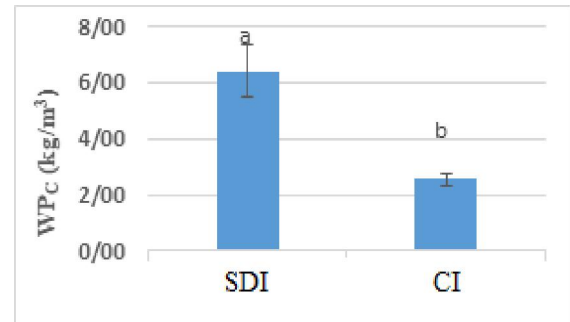
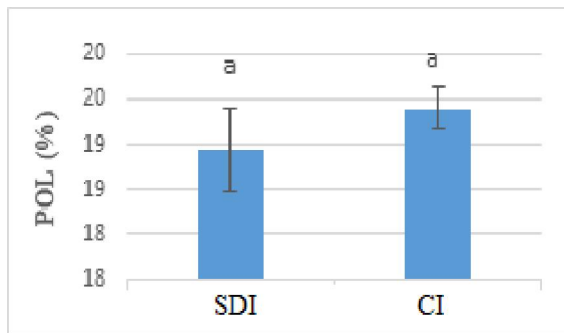

Figure 8. Pol and Brix in the subsurface drip irrigation and conventional irrigation

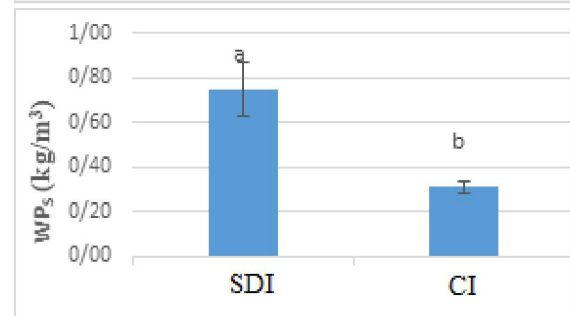
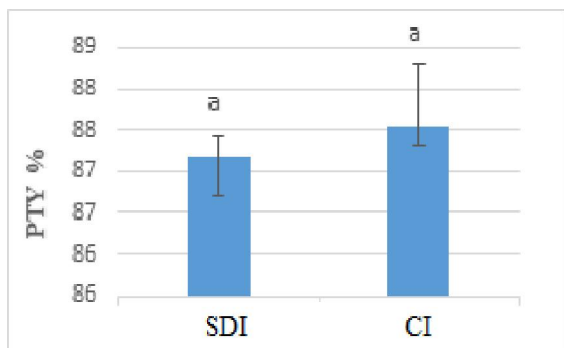

Figure 11. Water productivity for sugar cane production and sugar production in the subsurface drip irrigation and conventional irrigation

#### 4. Discussions

Subsurface drip irrigation is one of the best methods which was unknown for sugarcane cultivation. According to recent droughts and severe

water crisis in Iran, subsurface drip irrigation was implemented in sugarcane for the first time. Results of this experiment showed that the highest yield of sugarcane was in 50cm distance of the drippers, 15 and 20 cm depth of drippers and in 30 cm depth there was a significant difference in sugarcane yield. Also highest tiller density was in 50cm distance of drippers and 20cm depth which did not have significant difference with 15 and 30cm depth. Highest quality yield was in 60cm distance of the drippers and 15cm depth of the drippers which have significant difference with other depths. Highest yield of sugar was in 50cm distance of the drippers, 15cm and 20cm depth of drippers which has significant difference with 30cm depth of drippers. Sugarcane quality increased by decreasing water consumption and this is caused to high water productivity for produced sugar and sugarcane, so that in 60cm distance of the drippers, 15cm and 20cm depth of the drippers higher water productivity of produced sugarcane and sugar was  $7.18 \text{ kg/m}^3$  and  $0.87 \text{ kg/m}^3$ , respectively. Comparing results of quality and quantity yields of subsurface drip irrigation and surface irrigation show that most quantity and quality factors of subsurface drip irrigation were higher than the surface irrigation, so that water productivity in subsurface drip irrigation and surface irrigation system for produced sugarcane was  $6.41 \text{ kg/m}^3$  and  $2.57 \text{ kg/m}^3$ , respectively, and for produced sugar was  $0.75 \text{ kg/m}^3$  and  $0.31 \text{ kg/m}^3$ , respectively. According to the results and with considering uniform distribution of wetting pattern, salinity of the soil, no runoff, protecting the discharge pipe, no surface evaporation and the development of sugarcane root, 20cm depth for discharge pipe and 50cm distance of drippers on the lateral pipe is suggested. But due to high evaporation in some days and long duration of one irrigation period, 2 lit/hr discharge is suitable for drippers in this condition.

#### Acknowledgements:

This work was partly financed by the Khuzestan sugarcane institute.

#### Corresponding Author:

Ali Sheini Dashtegol  
Department of irrigation and drainage  
Shahid Chamran university of Ahvaz  
Ahvaz, Iran  
E-mail: [alidashtegol99@gmail.com](mailto:alidashtegol99@gmail.com)

#### References

1. Abbasi F, sheini-dashtegol A. 2016. *Evaluation and management improvement of furrow irrigation in Khuzestan sugarcane fields. Water and soil science journal* 26(2): 109-121. (in persian)
2. Allen R. G. Pereira L. S. Raes D. Smith M. 1998. *Crop evapotranspiration -guidelines for computing crop water requirements. FAO Irrigation and drainage paper 56. Food and Agriculture Organization, Rome.*
3. Anonymous. 1991. *sugarcane Research Institute of Khuzestan.*
4. Anonymous. 2014. *Rainbird XF series drip line. Design, installation and management guide.*
5. Ayars J. E. Fulton A. Taylor B. 2015. *Subsurface drip irrigation in California-Here to stay? Agric. Water Manage* 157: 39–47.
6. Ayars J. E. Phene C. J. Hutmacher R. B. Davis K. R. Schoneman R. a. Vail S. S. Mead R. M. 1999. *Subsurface drip irrigation of row crops: a review of 15 years of research at the Water Management Research Laboratory. Agric. Water Manage* 42: 1–27. [http://dx.doi.org/10.1016/S0378-3774\(99\)00025-6](http://dx.doi.org/10.1016/S0378-3774(99)00025-6).
7. Bull T. A. 1971. *Thecu path way related to growth rates in sugarcane. PP. 68-75. In: M. D. Hatch, C. B. Osmond and R. O. Slatyer (Eds.), Photosynthesis and Photorespiration. John Wiley Inc., USA.*
8. Burt C. M. 1998. *Selection of irrigation methods for agriculture: Drip/Microirrigation, Proceedings of the Water Resources Div., ASCE, Annual Conference, Memphis, T enn, ITRC Paper 98-004.*
9. Camp C. R. 1998. "Sugarcane drip irrigation: A review." *Trans. Am. Soc. Agr. Eng (ASAE)* 41(5): 1353–1367.
10. Çolak Y. B. Yazar A. Gönen E. Çağlar Eroğlu E. 2018. *Yield and quality response of surface and subsurface drip-irrigated eggplant and comparison of net returns. Agricultural Water Management* 206: 165–175.
11. Gil M. Rodriguez-Sinobas L. Juana L. Sanchez R. Losada A. 2008. *Emitter discharge variability of subsurface drip irrigation in uniform soils: effect on water-application uniformity. Irrig Sci* 26 (6): 451–458, <http://dx.doi.org/10.1007/s00271-008-0116-1>.
12. Goldberg D. Gornat B. Rimon D. 1976. *Drip irrigation principles. Design and agricultural practices. Drip Irrigation Scientific Publications, Kfar Shmaryahu, Israel.*
13. Lamm F. R. Bordovsky J. P. Schwankl L. J. Grawbow G. L. Enciso-Medina J. Peters, R. T. Colaizzi P. D. Trooien T. P. Porter D. O. 2011. *Subsurface drip irrigation: status of the technology in 2010. Trans. ASABE* 55: 483–491.
14. Lamm F. R. Camp C. C. 2007. "Subsurface drip irrigation." *Microirrigation for crop production: Design, operation, and management, F. R.*

- Lamm, J. E. Ayars and F. S. Nakayama, eds., Elsevier, Amsterdam, The Netherlands, 618.
15. Lamm F. R. Trooien T. P. 2003. "Subsurface drip irrigation for corn production: a review of 10 years of research in Kansas." *Irrig. Sci* 22(2-3): 195-200.
  16. Lamm F. R. Manges H. L. Stone L. R. Khan A. H. Rogers D. H. 1995. "Water requirement of subsurface drip-irrigated corn in northwest Kansas." *Trans. Am. Soc. of Agr. Eng (ASAE)*, 38(2): 441-448.
  17. Leonardo N. S. dos Santos. Edson E. Matsura. Ivo Z. Gonc. alves. Eduardo A. A. Barbosa Aline A. Nazário Natalia F. Tuta Marcelo C. L. Elaiuy Daniel R. C. Feitosa. Allan C. M. de Sousa. 2016. *Water storage in the soil profile under subsurface drip irrigation: Evaluating two installation depths of emitters and two water qualities. Agricultural Water Management* 170: 91-98.
  18. Martínez-Gimeno M. A. Bonet L. Provenzano G. Badal E. Intrigliolo D. S. Ballester C. 2018. *Assessment of yield and water productivity of clementine trees under surface and subsurface drip irrigation. Agricultural Water Management* 206: 209-216.
  19. N. S. dos Santos L. E. Matsura E. Z. Gonc. alves I. A. A. Barbosa E. A. Nazário A. F. Tuta N. C. L. Elaiuy M. R. C. Feitosa D. 2016. *Water storage in the soil profile under subsurface drip irrigation: Evaluating two installation depths of emitters and two water qualities. Agricultural Water Management* 170: 91-98.
  20. Najafi P. Tabatabaei S. H. 2007. *Effect of using subsurface drip irrigation and ET-HS model to increase WUE in irrigation of some crops. Irrig. and Drain* 56: 477-486.
  21. Pires R. C. M. Barbosa E. A. A. Arruda F. B. Sakai. E. da Silva T. J. A. 2014. *Effects of Subsurface Drip Irrigation and Different Planting Arrangements on the Yields and Technological Quality of Sugarcane. J. Irrig. Drain Eng.*
  22. Rallo G. Agnese C. Minacapilli M. Provenzano G. 2011. *Comparison of SWAP and FAO agro-hydrological models to schedule irrigation of wine grapes. J. Irrig. Drain. Eng* 138 (7): 581-591.
  23. Regina Célia M. P. Eduardo Augusto A. B. Flávio Bussmeyer A. Emílio S. Tonny Jose A. S. 2015. *Effects of Subsurface Drip Irrigation and Different Planting Arrangements on the Yields and Technological Quality of Sugarcane. ASCE. A5014001-1, J. Irrig. Drain. Eng.*
  24. Reyes-Cabrera J. Zotarelli L. D. Dukes M. L. Rowland D. A. Sargent S. 2016. *Soil moisture distribution under drip irrigation and seepage for potato production. Agricultural Water Management* 169: 183-192.
  25. Sheini -dashteghol A. Kashkooli A. Naseri A. A. Broomand nasab S. 2009. *effect of on other furrow irrigation on water productivity and sugarcane characteristics in south of Ahvaz. Water and soil science journal Isfahan industrial university* 13(49): 45-57. (in persian)
  26. Whalley H. C. S. DE. 1964. *ICUMSA methods of sugar analysis. Elsevier publishing company.*

8/20/2020