

The Supernatural “CNO” HUMAN?...
(A new theory on CNO Trinity of Nature)

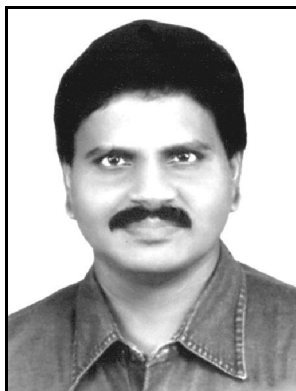

M.Arulmani, B.E.
(Engineer)
m.arulmani58@gmail.com



V.R.Hema Latha, M.A., M.Sc., M.Phil.
(Biologist)
vrhemalatha58@gmail.com

ABSTRACT: This research article focus that “CNO” shall be Considered as “**Three-in-one**” fundamental chemical Particle and “**Base**” of “**Chemical Universe**”. Millions of other chemical elements evolved subsequently shall be Considered as **Species** to CNO fundamental. “**Hydrogen Radiation**” shall be considered as the supernature CNO human and CNO shall be considered as the three-in-one fundamental organs of CNO Human. **Hydrogen** shall be considered as **centromere** of chemical Universe. **1) CARBON (C) – “MIND”**. **2) NITROGEN(N) – “LEFT HAND”**. **3) OZONE(O) “RIGHT HAND”**. It is further focused that “CNO Human” shall be considered as “Spontaneously” evolved from fundamental “**NEUTRINOS**” and therefore the CNO human shall be called as “**Supernatural**”. It is focused that the so called Dark Matter, Dark energy, Amino acids, Nucleotide base etc. shall be considered as “**Macro molecule**” evolved from “CNO Particle” due to impact of “Hydrogen radiation”. This research article is speculated to solve current mysteries theories about “Dark matter”, “Dark energy” of Universe. “Hydrogen shall be considered as species Radiation” to Neutrino Radiation rather than considered as Atom”.

[M. Arulmani, B.E., V. R. Hema Latha, M. A. **The Supernatural “CNO” HUMAN? (A new theory on CNO Trinity of Nature)**. *Cancer Biology* 2013;3(4):18-31]. (ISSN: 2150-1041). <http://www.cancerbio.net>. 3

Key Words

- i) Philosophy of Dark matter, Dark energy, Dark law.
- ii) Philosophy of three Generation CNO Cycle
- iii) Philosophy of “CNO” origin.
- iv) Philosophy of CNO based DNA, HORMONE, RNA.
- v) Philosophy of Expanding Universe

(i)

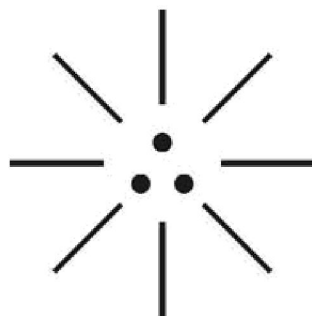
**(Neutrino Radiation)**

(ii)

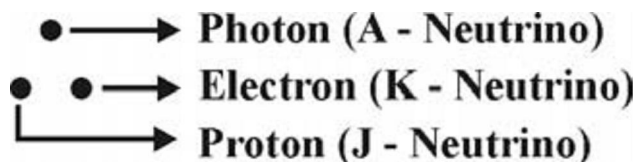

1. Introduction

It is focused that in the Material Universe Billions of Atoms, molecules existing shall be considered as **"One time evolution"** from Hydrogen radiation with initial definite molecular structure. These shall be called as **Natural elements, Natural molecules**. In the expanding Universe the Naturally evolved organic, non-organic elements shall be considered undergoing changes in various geological periods say in **"three generations"**: In brief the Trinity CNO fundamental Particles already evolved in Prehistoric time undergoing considerable changes in **Physical, chemical, mathematical** Properties shall be considered as **"three species"** to the fundamental "CNO" Particles.

1) CNO first generation(Prehistoric time)	-	1st species.
2) CNO 2 nd generation(Ancient time)	-	2nd species
3) CNO 3 rd generation(modern time)	-	3rd species

It is focused that the three species CNO shall be considered as deviation in properties in the materiel universe compared to Prehistoric time which may be the reason for various medical Problems such as frequent Heart attack, fast cancer growth, various disease like Dengue fever, Bird fever, AIDS, climate change issues such as severe cyclone, sudden forest fire etc. This research focus that the Human Ancestor on origin had very **least cell mass, least PH value, Higher intensity of eye Iris colour**. This research also focus that every human on **evolution** has different cell mass and the cell mass of every human **can not exactly match** with other individual even with **same family**. Billions of human evolved subsequently from **"prehistoric human ancestor"** shall be considered as Billions of **"Species"** to Prehistoric **"3G Human"**. It is speculated that considerable **bandwidth** difference in cell mass of Human may lead to vast different **genetic characteristics** among human in the expanding universe.

2. Previous Publications

The philosophy of origin of first life and human, the philosophy of model Cosmo Universe, the philosophy of fundamental neutrino particles have already been published in various international journals mentioned below. Hence this article shall be considered as **extended version** of the previous articles already published by the same author.

- [1] Cosmo Super Star – IJSRP, April issue, 2013
- [2] Super Scientist of Climate control – IJSER, May issue, 2013
- [3] AKKIE MARS CODE – IJSER, June issue, 2013
- [4] KARITHIRI (Dark flame) The Centromere of Cosmo Universe – IJIRD, May issue, 2013
- [5] MA-AYYAN of MARS – IJIRD, June issue, 2013
- [6] MARS TRIBE – IJSER, June issue, 2013
- [7] MARS MATHEMATICS – IJERD, June issue, 2013
- [8] MARS (EZHEM) The mother of All Planets – IJSER, June issue, 2013
- [9] The Mystery of Crop Circle – IJOART, May issue, 2013
- [10] Origin of First Language – IJIRD, June issue, 2013
- [11] MARS TRISOMY HUMAN – IJOART, June issue, 2013
- [12] MARS ANGEL – IJSTR, June issue, 2013
- [13] Three principles of Akkie Management (AJIBM, August issue, 2013)
- [14] Prehistoric Triphthong Alphabet (IJIRD, July issue, 2013)
- [15] Prehistoric Akkie Music (IJST, July issue, 2013)
- [16] Barack Obama is Tamil Based Indian? (IJSER, August issue, 2013)
- [17] Philosophy of MARS Radiation (IJSER, August 2013)
- [18] Etymology of word “J” (IJSER, September 2013)
- [19] NOAH is Dravidian? (IJOART, August 2013)
- [20] Philosophy of Dark Cell (Soul)? (IJSER, September 2013)
- [21] Darwin Sir is Wrong?! (IJSER, October issue, 2013)
- [22] Prehistoric Pyramids are RF Antenna?!... (IJSER, October issue, 2013)
- [23] HUMAN IS A ROAM FREE CELL PHONE?!... (IJIRD, September issue, 2013)
- [24] NEUTRINOS EXIST IN EARTH ATMOSPHERE?!... (IJERD, October issue, 2013)
- [25] EARLY UNIVERSE WAS HIGHLY FROZEN?!... (IJOART, October issue, 2013)
- [26] UNIVERSE IS LIKE SPACE SHIP?!... (AJER, October issue, 2013)
- [27] ANCIENT EGYPT IS DRAVIDA NAD?!... (IJSER, November issue, 2013)
- [28] ROSETTA STONE IS PREHISTORIC “THAMEE STONE” ?!... (IJSER, November issue, 2013)
- [29] 3G HUMAN ANCESTOR?... (IJERD, December issue, 2013)

3. Hypothesis

- 1) The Cosmo Universe shall be considered having “three” distinguished regions (i.e.) Antineutrino radiation region, Neutrino radiation region, Electromagnetic radiation region.

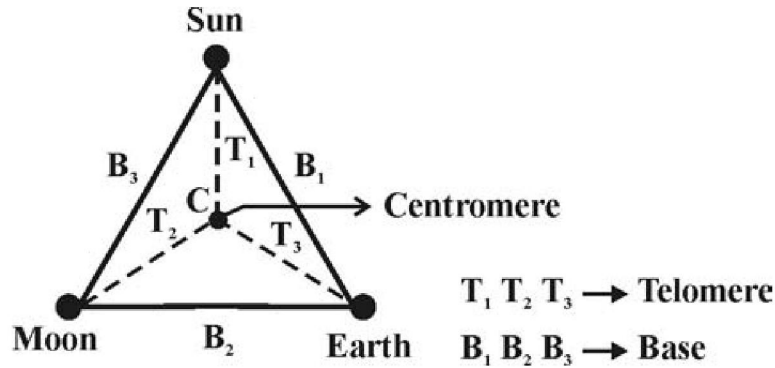

(Model Cosmo Universe)

- 2) The Electromagnetic radiation region shall also be called as “Einstein Region” (or) material Universe region where all matter exists including all space objects such as **MARS, SUN, EARTH, MOON**, various organisms like Microbes, Bacteria, plants, animals, human etc..
- 3) The Electromagnetic radiation (EMR) shall be considered as responsible for existence of entire material Universe under “electromagnetic equilibrium condition”. The property of material Universe shall be considered constantly varying since Prehistoric time due to subsequent increase in “**Mass of Neutrino particles**” in CNO Composition.
- 4) The variation in CNO Property of material Universe shall be sensed only in considerable “**Bandwidth of time**” say 100 to 1000 Years.
- 5) The “CNO” shall be considered as Three-in-one species (Trinity) evolved from “Hydrogen radiation”. This elements shall be considered as “**Fundamental CNO**”. Billions of other elements of Universe generated during Ancient time, Modern time shall be considered as “**sub species**” to the “fundamental CNO”.

(i)

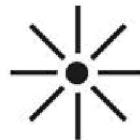

(Hydrogen Radiation)

(ii)

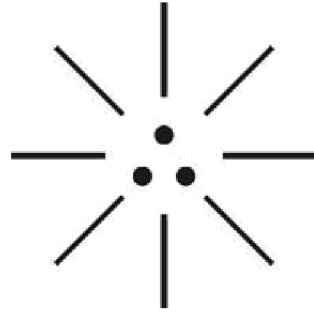

(CNO Fundamental)

(iii)

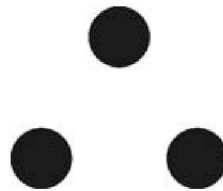

(CNO Trinity)

(iv)

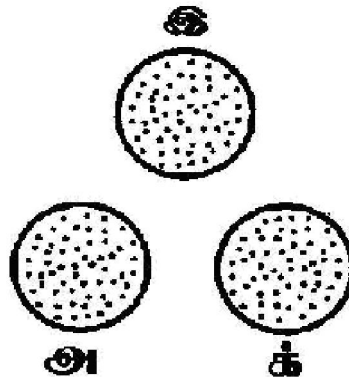

(CNO Species)

(v)

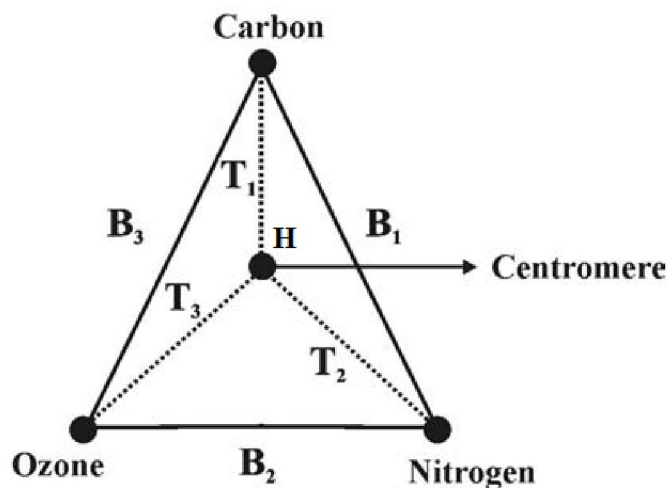

- 6) The fundamental CNO shall be considered having definite Molecular structure on origin. The billions of CNO subspecies shall be considered having **deviated molecular structure** due to subsequent gaining of mass in Neutrino Particles in 2nd, 3rd generation of geological periods.



(CNO Based Molecular Structure)

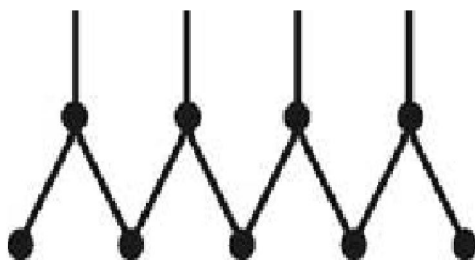

(CNO Based Macro Molecule)

- 7) The fundamental neutrinos shall be considered having pre defined structure and subject to “**sustained oscillation**” which shall be considered as responsible for ‘**genome effect**’ of existence of billions of elements of CNO material universe.
- 8) The philosophy of CNO based molecular structure of billions of elements of material universe shall be considered derived from the philosophy of fundamental neutrinos and its oscillation.

(i)

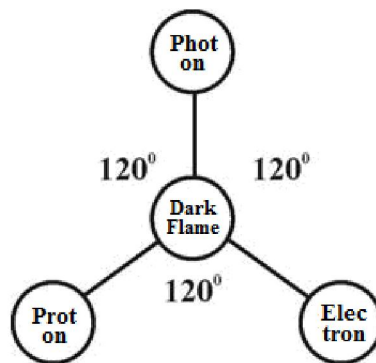
**(Neutrino Oscillation)**

(ii)

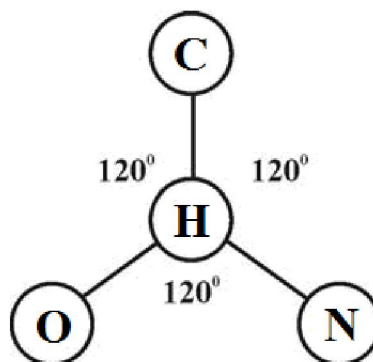
**(CNO Structural Diversity)**

- 9) The prehistoric fundamental CNO particles shall be considered as “**Dark Particles**” having dark colour. In expanding universe the CNO fundamental CNO based elements might have attained different colour in 2nd, 3rd generation of geological periods mainly into “Three-in-one” fundamental colour DARK BLUE, DARK GREEN, DARK RED. Billions of colours of various elements in the material universe shall be considered as subspecies colours to the three fundamental colours of “CNO”. “Hydrogen radiation” shall be considered as “Absolutely white radiation”. It is speculated that the Hydrogen radiation might have been evolved from Electromagnetic radiation (EMR) when the “SUN” starts emits first red radiation in the Early Universe.
- 10) The “**DARK MATTER**” shall be considered as the “**composite Neutrino matter**” evolved from fundamental neutrinos. The smallest unit of Dark matter shall be considered as “**DARK ATOM**”.

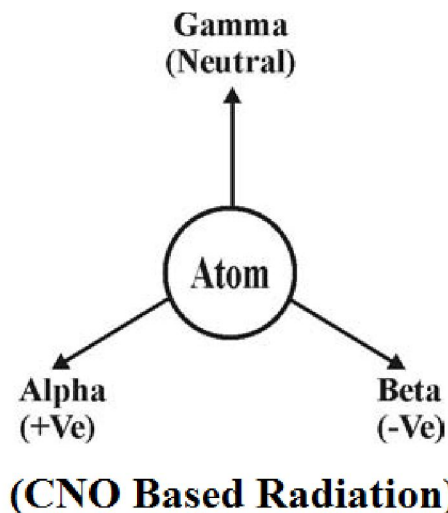

- 11) The “DARK ENERGY” shall be considered as the “Composite Neutrino Energy” evolved from fundamental neutrinos. The smallest unit of Dark Energy shall be considered as the “DARK CELL”.

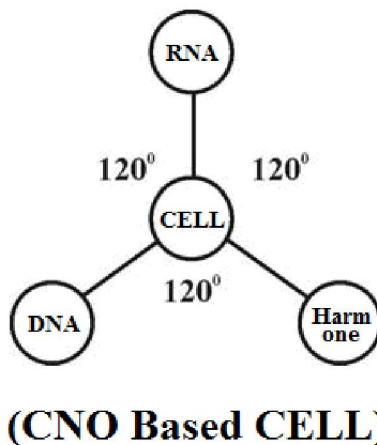

- 12) The Dark Atom, Dark Cell shall be considered having exactly opposite in characteristics under the control of Hydrogen radiation. The hydrogen radiation having genome effect in maintaining equilibrium under particular environment condition shall also be called as “DARK LAW”
- 13) The philosophy of “CNO cycles” might be derived from the philosophy of deviation in fundamental CNO molecular structure, properties in **three generation** of geological periods.
- 14) The philosophy of “**Three domain**” of life and its colour variation might be derived from the philosophy of three-in-one fundamental neutrinos, and three-in-one fundamental CNO particles of material universe.
- 15) The whole material universe shall be considered as “**SUPERNATURAL CNO HUMAN**” emanating Hydrogen radiation from his **HEART**. The CNO shall be considered as three fundamental organs of “CNO HUMAN”.

(i)

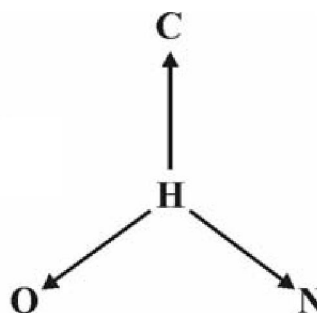
**(CNO Molecular Structure)**

(ii)

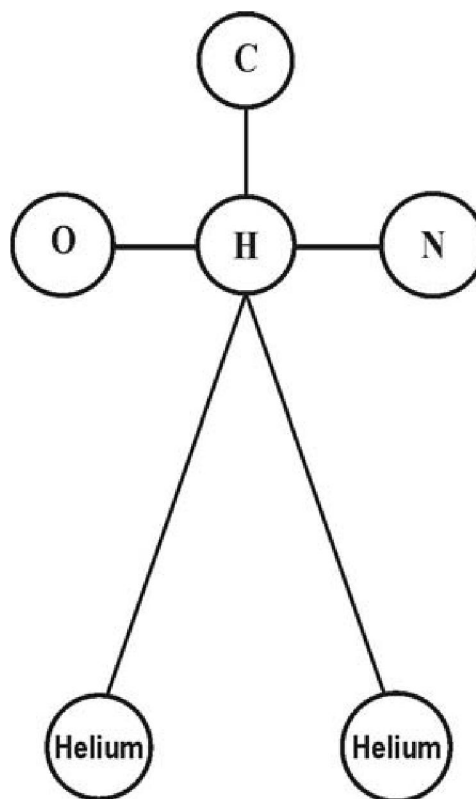
**(SUPER NATURAL CNO HUMAN)****4. Hypothetical Narration****a) Philosophy of Three generations Human blood?...**

It is hypothesized that Human blood shall be considered as the Natural Product due to impact of fundamental neutrinos photon neutrino, electron neutrino, proton neutrino. The blood shall be called as “**Neutrino fluid**”. In the expanding universe the human blood shall be classified into three types based CNO variation in three geological periods.

1) DARK BLOOD – CNO Origin

- 2) **DARK BLUE BLOOD** – 1st generation
- 3) **DARK GREEN BLOOD** – 2nd generation
- 4) **DARK RED BLOOD** – 3rd generation

It is speculated that the blood of prehistoric human shall be considered as highly **ACIDIC** and the PH Value might be well below **7.0**.

b) Philosophy of Three generation Human eye iris?...

It is hypothesized that the human eye-iris shall be classified into three fundamental coloured Iris based on CNO variation.

- 1) **DARK Iris** – Prehistoric human origin.
- 2) **DARK BLUE Iris** – 1st generation
- 3) **DARK GREEN Iris** – 2nd generation
- 4) **DARK RED Iris** – 3rd generation

It is speculated that Billions of Iris colour variations among global populations shall be considered as **species** to the fundamental three colour iris.

c) Philosophy of Prehistoric water (H₂O)...

It is focused that the prehistoric water shall be considered as highly influenced with **OZONE** rather than **OXYGEN**. Oxygen shall be considered as species to **OZONE** evolved subsequently at later period. It is hypothesized that in the early universe the **OCEAN** might have been formed due to condensation of **OZONE** particles even much before evolution of oxygen.

It is further focused that the prehistoric Ocean water might be highly Acidic having PH value much below 7.0 and subsequently become Alkali in modern time.

“OZONE WATER might be dialectally pronounced as OCEAN WATER”

– Author.

d) Philosophy of Human Origin?...

It is hypothesized that the prehistoric human shall be considered as “Neutrino product **spontaneously** evolved due to impact of fundamental neutrinos radiation and CNO based matter. It is speculated that the prehistoric human might have lived in **MARS PLANET** with different genetic characteristics and capable of “**FLYING**”.

It is further speculated that the prehistoric human might have **OZONE BREATH** and the blood might be highly **DARK** in colour and highly **ACIDIC**.

The prehistoric human shall be called as “**AL-J**” alias “**CNO AL-J**” shall mean evolved spontaneously from fundamental neutrinos particles.

It is speculated that the prehistoric human had only **3 chromosome** on origin derived from three fundamental neutrinos. In the expanding universe millions of humans generated shall be considered as **species** to 3 chromosome human having definite structure.

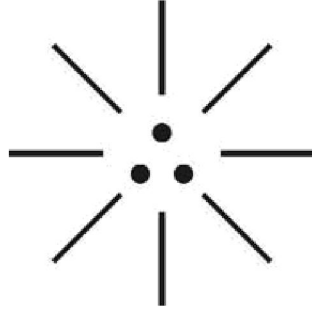

(CNO Trinity Fundamental)

The bottom two dot shall be considered as “Autosome” having directly opposite in characteristics. The centre dot shall be considered as “Sex chromosome”. The prehistoric human lived in MARS PLANET shall also be called GODLY PERSON and TRISOMY HUMAN.

It is speculated that during the course of expanding universe the subsequent human species gradually switched over to “OXYGEN BREATH” from OZONE BREATH and started living in EARTH PLANET with different genetic characteristics. It is speculated that ANGELS shall be considered as 1st generation human species to prehistoric CNO HUMAN. The Biblical “ADAM” shall be considered as 2nd generation human species. The Biblical “NOAH” population origin shall be considered as 3rd generation human species.

e) How “AL-J’ looks like?...

(i)

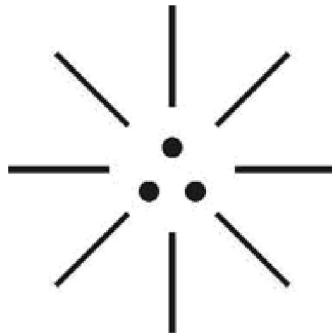

(The Law of Universe)

(ii)

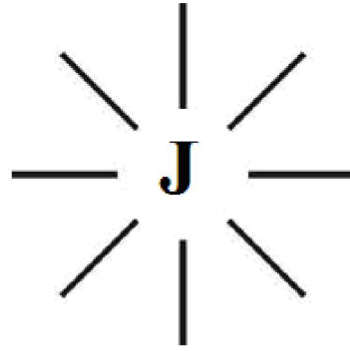

(Cosmo Superstar)

(iii)

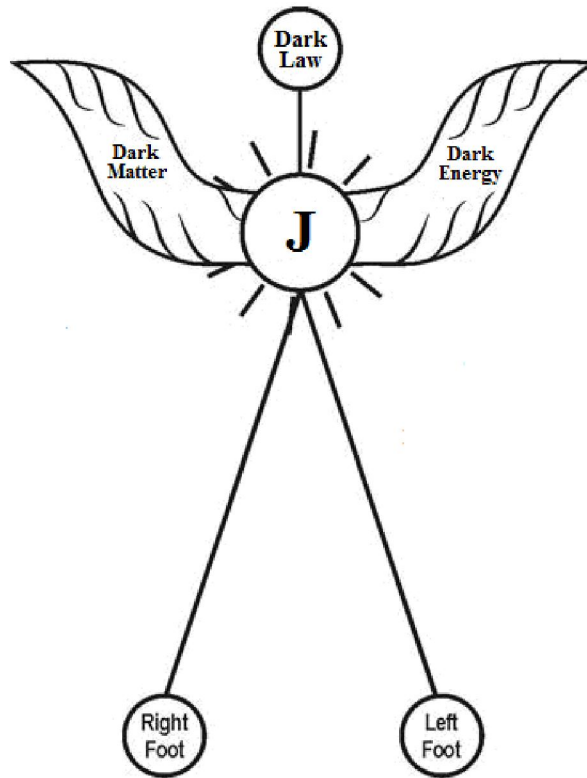

(AL-J alias CNO)

“UNIVERSE shall alternatively mean J-RADIATION”

– Author.

Bible source:
Bible evidence shows that prehistoric human populations are capable of flying in the sky
 (Ps 91:4, Ps 36:7, Ruth 2:12, Luk 2:10-13, Mal 4:1-5).

5. Conclusion

It is speculated that the 1st generation human lived in MARS shall be considered as **SUPER SCIENTISTS** and expert in Astronomy, Astrophysics and controlled effectively the relative position of **SUN, EARTH, MOON** on its axis

(i)

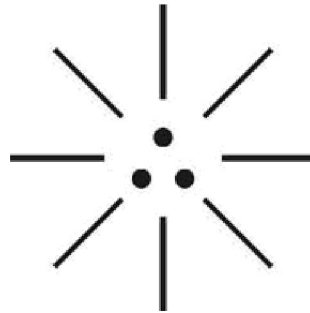

(SUN, EARTH, MOON)

(ii)

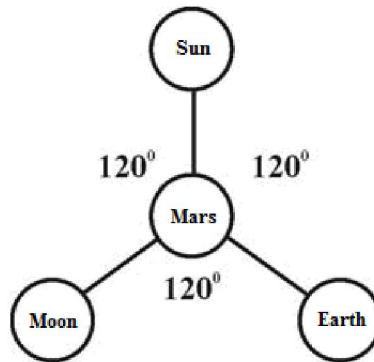

(CNO Universe)

It is speculated that the 1st, 2nd generation human could have been completely extinct at one stage and the prehistoric technology might have been totally destroyed. The so called modern human (3rd generation human) probably could not be effectively control or manage the movement of space objects as was done by 1st generation human.

It is speculated that present day severe climatic issues such as frequent Earth quake, cyclone, sudden forest fire, volcanic activity might be due to "**misalignment**" in relative position of **SUN, EARTH, MOON**.

The philosophy of **EXPANDING UNIVERSE** shall be considered as closely associated with rotation of **INNER CORE** of Sun also on its axis. It is speculated that the inner core of Sun is expected to have only **ONE CYCLE** in the entire cosmological period. It is further speculated that the origin of CNO

human might be evolved when inner core of Sun begins to rotate in prehistoric time and it will complete one cycle probably by 3000AD.

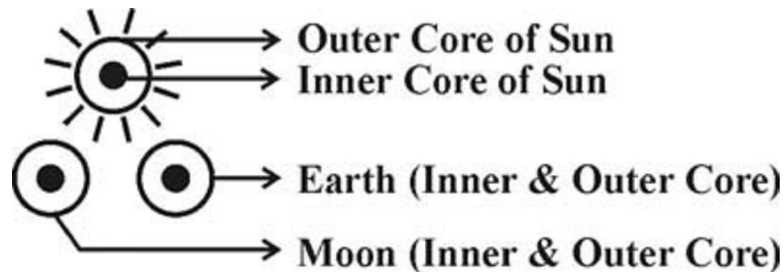

6. REFERENCE

- [1] Intensive Internet “e-book” study through, Google search and wikipedia
- [2] M.Arulmani, “3G Akkana Man”, Annai Publications, Cholapuram, 2011
- [3] M. Arulmani; V.R. Hemalatha, “Tamil the Law of Universe”, Annai Publications, Cholapuram, 2012
- [4] Harold Koontz, Heinz Weihriah, “Essentials of management”, Tata McGraw-Hill publications, 2005
- [5] M. Arulmani; V.R. Hemalatha, “First Music and First Music Alphabet”, Annai Publications, Cholapuram, 2012
- [6] King James Version, “Holy Bible”
- [7] S.A. Perumal, “Human Evolution History”
- [8] “English Dictionary”, Oxford Publications
- [9] Sho. Devaneyapavanar, “Tamil first mother language”, Chennai, 2009
- [10] Tamilannal, “Tholkoppiar”, Chennai, 2007
- [11] “Tamil to English Dictionary”, Suravin Publication, 2009
- [12] “Text Material for E5 to E6 upgradaton”, BSNL Publication, 2012
- [13] A. Nakkiran, “Dravidian mother”, Chennai, 2007
- [14] Dr. M. Karunanidhi, “Thirukkural Translation”, 2010
- [15] “Manorama Tell me why periodicals”, M.M. Publication Ltd., Kottayam, 2009
- [16] V.R. Hemalatha, “A Global level peace tourism to Veilankanni”, Annai Publications, Cholapuram, 2007
- [17] Prof. Ganapathi Pillai, “Sri Lankan Tamil History”, 2004
- [18] Dr. K.K. Pillai, “South Indian History”, 2006
- [19] M. Varadharajan, “Language History”, Chennai, 2009
- [20] Fr. Y.S. Yagoo, “Western Sun”, 2008
- [21] Gopal Chettiar, “Adi Dravidian Origin History”, 2004
- [22] M. Arulmani; V.R. Hemalatha, “Ezhem Nadu My Dream” - (2 Parts), Annai Publications, Cholapuram, 2010
- [23] M. Arulmani; V.R. Hemalatha, “The Super Scientist of Climate Control”, Annai Publications, Cholapuram, 2013, pp 1-3

12/11/2013