

E-ACHI, IAS?...
(A new theory on "e-politics")

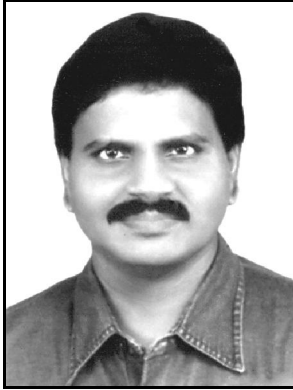

M. Arulmani, B.E.
(Engineer)

m.arulmani58@gmail.com



V.R. Hema Latha, M.A., M.Sc., M.Phil.
(Biologist)

vrhemalatha58@gmail.com

Abstract: This scientific research article focus that the entire existence of Cosmo universe and its matters shall be considered as "**Creations**" rather than "**evolution**". All matters shall be considered as created through "**J-RADIATION**" emanated from the Heart of creator or "**GOD**". In prehistoric Tamil, the Heart of God shall be called as "**EZHEM**" (Thai-e) and acronymically indicated as below.

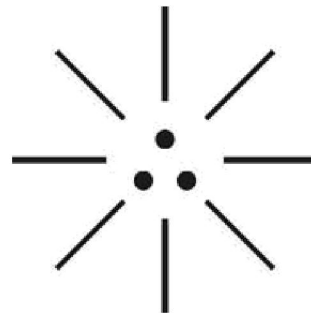

("E")

This research further focus that the Prehistoric Tamil based Indian populations (ENDOS) lived in "**MARS PLANET**" (the first land origin of Universe) shall be considered as expert in Astrophysics, Astronomy and effectively controlled the **Environmental pollution**. The principle of control system adopted by them being classified under fundamental "**Three Domain**" called "**IAS**". Each domain shall be considered as composed of billions of "**Sub logics**" responsible for "**Micro management**" in each domain system for ensuring overall "Balance" or **system symmetry** of Pollution free universe. It is focused that in the early universe the Universe was very symmetric and pollution free and subsequently due to **growth of matter**, environment pollution started increasing and hence control over particles felt required. "**e-politics**" shall mean systematic scientific study of characteristics of fundamental particles and control over the matter Generation through three domain.

(i)

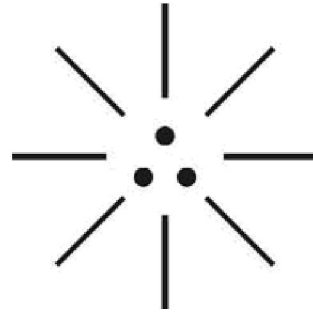
**(IAS)**

(ii)

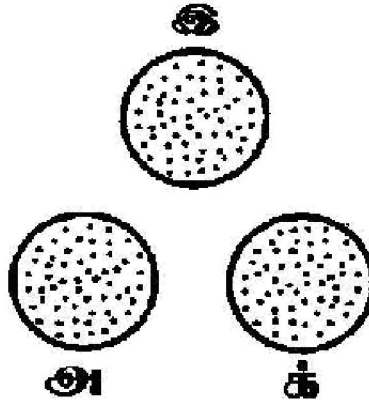
**(IAS-Sub logics)**

Further in prehistoric time the “ENDOS” shall be considered living under single “**Joint family**” called “**MARS FAMILY**”. ‘E-ACHI’ shall be considered as “**Ezhem Achi**” or “**Mother of Mars**”.

(i)

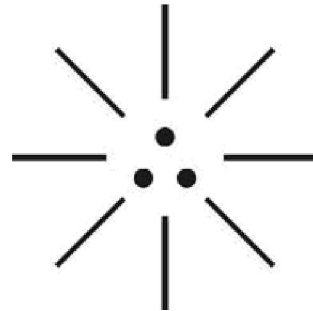
**(MARS)**

(ii)

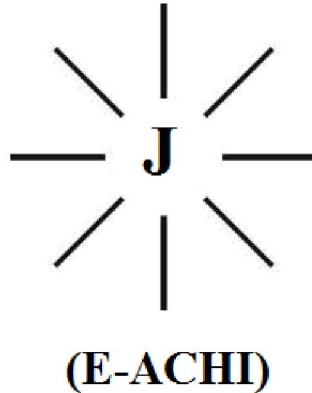

“The Philosophy of Tamil words chularchi, Purachi, Malarchi, Valarchi, Mazhilchi, Thalarchi, Meenachi, Kamachi might be derived from the philosophy of “E-ACHI”. The E-Achi shall also mean radiant energy ensuring “Divine and Balanced Rule”.

- Author

[M.Arulmani, B.E., V.R.Hema Latha, M.A., M.Sc., M.Phil. E-ACHI, IAS?... (A new theory on “e-politics”). Academ Arena 2014;6(3):58-77]. (ISSN 1553-992X). <http://www.sciencepub.net/academia>. 7

1. Key Words:

- a) Philosophy of “WHITE INK”
- b) Philosophy of “WHITE BOX”
- c) Philosophy of “ENDO”
- d) Philosophy of “INDO”
- e) Philosophy of “ECTO”
- f) Philosophy of “PAL-E”
- g) Philosophy of “IAS”
- h) Philosophy of “E-ACHI”
- i) Philosophy of “E-POLITICS”
- j) Philosophy of “AAN-PAL” (Male)
- k) Philosophy of “PEN-PAL” (Female)
- l) Philosophy of “THAI-PAL” (Infant)
- m) Philosophy of “MU-PAL” (Family)
- n) Philosophy of “PARLIAMENT”
- o) Philosophy of EGG UNIVERSE

2. Introduction:

It is focused that “**ENDOS**” shall be considered as the prehistoric human populations lived in MARS PLANET even before origin of first “**SUN LIGHT**” rays. In “**MARS FAMILY**” mother shall be considered as the “Prime Authority” (or) “Prime Minister” of the family and the “**Key of Treasury**” is considered kept under the control of mother. Further in mars family “**FATHER**” is kept under “**Dummy**” and simply dancing according to mother’s forefinger direction. The children of the mars family are so clever and enjoying all the benefits from mother saying **ACHI... ACHI... AMMACHI...** and keeping the father in one corner.

During the course of time some of the children started supporting Father and “**family politics**” started and single joint family started split into **prime three division** in the family. In Mars family the Father shall be called as “**E-MGR**”. **E-MGR** shall mean “**Mars Geo Ruler**” who has constructed “**Egyptian Pyramids**”.

- i) ENDO JOINT FAMILY
- ii) INDO MOTHER FAMILY

iii) INDO FATHER FAMILY

When **INDO family** started growing up, (after marriage of children) more “**internal politics**” started within the family due to difference of opinion among **mother-in-law** and **daughter-in-law**. It is speculated that the philosophy of “**Global Politics**” might be (based on Mars family) derived from the characteristics and behaviour of fundamental particles of Universe **Photon, Electron, Proton**.

(i)

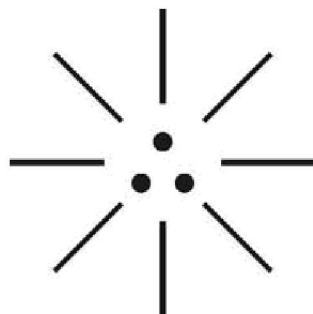

(Photon, Electron, Proton)

(ii)

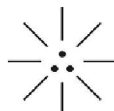

(MIN-ACHI, IAS)

“The philosophy of Tamil Word URACHI, ULLACHI, VATTACHI, NAGARACHI, MANNARACHI, MAKKALACHI ENGA ACHI, might be derived from the philosophy of MIN-ACHI”. MIN-ACHI shall mean ACHI expert in controlling of particles and Ruler of Mars family.

– Author.

3. Previous Publication:

The philosophy of origin of first life and human, the philosophy of model Cosmo Universe, the philosophy of fundamental neutrino particles have already been published in various international journals mentioned below. Hence this article shall be considered as **extended version** of the previous articles already published by the same author.

- [1] Cosmo Super Star – IJSRP, April issue, 2013
- [2] Super Scientist of Climate control – IJSER, May issue, 2013
- [3] AKKIE MARS CODE – IJSER, June issue, 2013
- [4] KARITHIRI (Dark flame) The Centromere of Cosmo Universe – IJIRD, May issue, 2013
- [5] MA-AYYAN of MARS – IJIRD, June issue, 2013
- [6] MARS TRIBE – IJSER, June issue, 2013

- [7] MARS MATHEMATICS – IJERD, June issue, 2013
 [8] MARS (EZHEM) The mother of All Planets – IJSER, June issue, 2013
 [9] The Mystery of Crop Circle – IJOART, May issue, 2013
 [10] Origin of First Language – IJIRD, June issue, 2013
 [11] MARS TRISOMY HUMAN – IJOART, June issue, 2013
 [12] MARS ANGEL – IJSTR, June issue, 2013
 [13] Three principles of Akkie Management (AJIBM, August issue, 2013)
 [14] Prehistoric Triphthong Alphabet (IJIRD, July issue, 2013)
 [15] Prehistoric Akkie Music (IJST, July issue, 2013)
 [16] Barack Obama is Tamil Based Indian? (IJSER, August issue, 2013)
 [17] Philosophy of MARS Radiation (IJSER, August 2013)
 [18] Etymology of word “J” (IJSER, September 2013)
 [19] NOAH is Dravidian? (IJOART, August 2013)
 [20] Philosophy of Dark Cell (Soul)? (IJSER, September 2013)
 [21] Darwin Sir is Wrong?! (IJSER, October issue, 2013)
 [22] Prehistoric Pyramids are RF Antenna?!... (IJSER, October issue, 2013)
 [23] HUMAN IS A ROAM FREE CELL PHONE?!... (IJIRD, September issue, 2013)
 [24] NEUTRINOS EXIST IN EARTH ATMOSPHERE?!... (IJERD, October issue, 2013)
 [25] EARLY UNIVERSE WAS HIGHLY FROZEN?!... (IJOART, October issue, 2013)
 [26] UNIVERSE IS LIKE SPACE SHIP?!... (AJER, October issue, 2013)
 [27] ANCIENT EGYPT IS DRAVIDA NAD?!... (IJSER, November issue, 2013)
 [28] ROSETTA STONE IS PREHISTORIC “THAMEE STONE” ?!... (IJSER, November issue, 2013)
 [29] The Supernatural “CNO” HUMAN?... (IJOART, December issue, 2013)
 [30] 3G HUMAN ANCESTOR?... (AJER, December issue, 2013)
 [31] 3G Evolution?... (IJIRD, December issue, 2013)
 [32] God Created Human?... (IJERD, December issue, 2013)
 [33] Prehistoric “J” – Element?... (IJSER, January issue, 2014)
 [34] 3G Mobile phone Induces Cancer?... (IJERD, December issue, 2013)
 [35] “J” Shall Mean “JOULE”?... (IRJES, December issue, 2013)
 [36] “J”- HOUSE IS A HEAVEN?... (IJIRD, January issue, 2014)
 [37] The Supersonic JET FLIGHT-2014?... (IJSER, January issue, 2014)
 [38] “J”-RADIATION IS MOTHER OF HYDROGEN?... (AJER, January issue, 2014)
 [39] PEACE BEGINS WITH “J”?... (IJERD, January issue, 2014)
 [40] THE VIRGIN LIGHT?... (IJCRAR, January issue 2014)
 [41] THE VEILED MOTHER?... (IJERD, January issue 2014)
 [42] GOD HAS NO LUNGS?... (IJERD, February issue 2014)
 [43] Matters are made of Light or Atom?!... (IJERD, February issue 2014)
 [44] THE NUCLEAR “MUKKULAM”?... (IJSER, February issue 2014)
 [45] WHITE REVOLUTION 2014-15?... (IJERD, February issue 2014)
 [46] STAR TWINKLES!?!... (IJERD, March issue 2014)
 [47] “E-LANKA” THE TAMIL CONTINENT?... (IJERD, March issue 2014)
 [48] HELLO NAMESTE?... (IJSER, March issue 2014)
 [49] MOTHERHOOD MEANS DELIVERING CHILD?... (IJERD, March issue 2014)

4. Hypothesis:

a) Philosophy of Akki-e family?...

It is hypothesized that every ray emitted from “J-RADIATION” shall be considered as the family of different gene creations of matter. Akki-e family shall be considered as the “fundamental particle” (or) Natural particle family. Some of the Natural families created shall be indicated as below: (“e” stands for EZHEM)

- | | | |
|--------------|---|-------------------------|
| i) “The-e” | – | Radiation family |
| ii) “Akki-e” | – | Particles family |
| iii) “All-e” | – | Human family |
| iv) “Ape-e” | – | Monkey family |

v) “**Acce-e**” - **Plant** family

b) Philosophy of fundamental particles?...

It is hypothesized that “**J-RADIATION**” shall be considered as the fundamental radiation composed of Three-in-one particles “**PHOTON**”, “**ELECTRON**” “**PROTON**” (**Akki-e**) having **Zero mass** and definite properties. The smallest unit of J-Radiation shall be called as “**J-CELL**”.

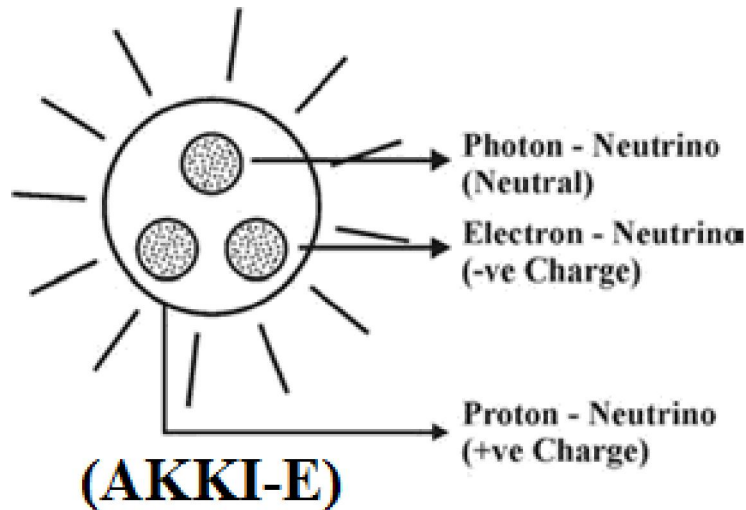

c) Philosophy of “IAS”?...

It is hypothesized that in the early universe the system characteristics of fundamental particles shall be considered under three major classifications called “Three domain” written in **WHITE INK** and monitored through “**WHITE BOX**”.

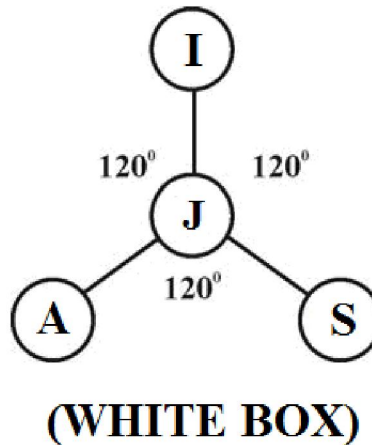

- i) Centre domain - “**I**” (Intelligence wing)
- ii) Left Domain - “**S**” (Science Wing)
- iii) Right Domain - “**A**” (Art wing)

“**Intelligence**” is like **Photon** dominated

“**Science**” is like **Electron** dominated

“**Art**” is like **Proton** dominated

Further in Akki-e family strategy the three domain “**IAS**” shall also be considered as representing three wings, say **Law, Functional, structural** part of the system. Thousands of internet slang words, acronyms, abbreviations based on **IAS** might be derived from the Philosophy of Akki-e family three domain.

d) Etymology of word IAS?...

Case study shows that thousands of slang words, Abbreviations, Acronyms exist based on “**IAS**”.

- i) Indian Administrative Service (India)
- ii) International Astrophysique Spatiale (France)
- iii) Increased Attack Speed (Diablo)
- iv) Inertial Active system (NASA)
- v) Internet Authentication Services (Microsoft)
- vi) Internet Application Server
- vii) Inteartial Septum (Cardiology)

“The philosophy of English word “IAS” might be derived from the philosophy of prehistoric Tamil phonetics “Ayes”. “Ayes” shall mean “ACHI (or) MOTHER”

- *Author*

e) Philosophy of e-politics?...

It is hypothesized that in **Akki-e family**, the three particles shall be considered as three members of the family as indicated below:

(1)

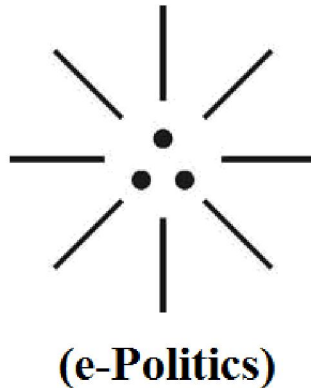

(2)

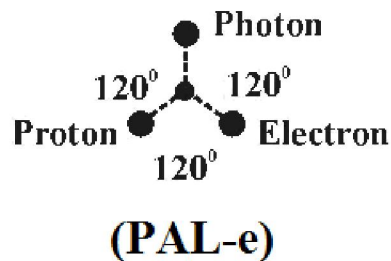

- i) **Photon** – Father (Ay-e)
- ii) **Electron** – Mother (Mai-e)
- iii) **Proton** – Infant (Thai-e)

Further three particles shall be considered having “**GENDER**” identity and called in prehistoric Tamil as below.

- i) **Photon** – Neutral – PAL (Dual)
- ii) **Electron** – PEN – PAL (Female)
- iii) **Proton** – AAN-PAL (Male)

It is hypothesized that the particles shall be considered acquired colour during expanding universe which led to generation of colourful matters in the universe. “**Pal-e**” shall be considered as “**absolutely White**”.

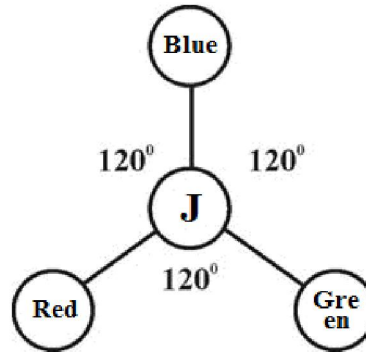

(Tri-Colour Particles)

The philosophy of e-politics (**PAL-EYAL**) shall be defined within the following scope.

- i) **e-politics** shall mean scientific study of fundamental particles
- ii) **e-politics** shall mean effective control of fundamental particles
- iii) **e-politics** shall mean gender property of species particles.
- iv) **e-politics** shall mean colour property of species particles.

f) Philosophy of evolution of matters?...

It is hypothesized that during the expanding universe the initially created “**Natural matters**” shall be considered have undergone **three genetic changes** due to increased in “**MASS**” and genetic structure variation in fundamental particles and thereby “**genetically varied species**” matters shall be considered evolved in three nuclear, geological ages. It is focused that the evolution of three Generation matters shall be considered due to impact of “**INTERNAL POLITICS**” among PHOTON, ELECTRON, PROTON domination in different ages.

- (i) “**Photon domination**” – Ist Generation matters
- (ii) “**Electron domination**” - IInd Generation matters
- (iii) “**Proton domination**” – IIIrd Generation matters

“Expanding Universe shall mean consistent growth of matters in the Universe due to “e-politics” of particles”.

- Author

g) Philosophy of “EGG” Universe?...

It is hypothesized that in the early universe the shape of universe shall be considered as highly symmetric and during the course “**SPACE**” and “**TIME**” the shape of Universe shall be consistently altered and become “**EGG**” like shape with existence of different genetic matters in different regions.

- (i)

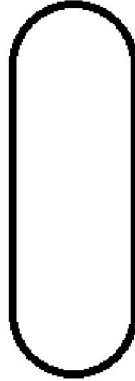

(Early Universe)

(ii)

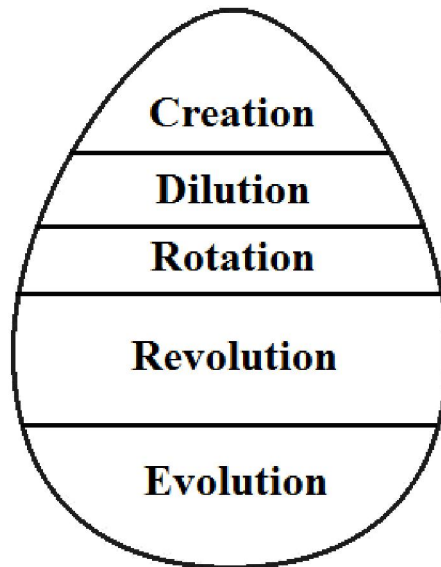

(Expanding Universe)

The different phase of changes shall be indicated as below.

- | | | |
|------------------|---|-----------------------|
| i) "Creation" | - | Origin of matters |
| ii) "Dilution" | - | Transformation |
| iii) "Rotation" | - | 1 st phase |
| iv) "Revolution" | - | 2 nd phase |
| v) "Evolution" | - | 3 rd phase |

g) Philosophy of word AYE, ACHI?...

Case study shows that the phonetics **ACHI** is closely related to Mayan language "**K'iche**". Further Mayan language family is one of the best documented and most studied in the Americans considered descended from "**PROTO-MAYAN**" which is thought to have spoken at least 5000 years ago and written in "**Mayan Hieroglyphs**".

It is hypothesized that "**Mars family**" language shall be considered originated in Prehistoric time say **2,00,000 years ago**. Mars family language shall be considered as "**Single alphabet**" composed of "**three-in-one**". Tiny dot called in Modern English as "**TRIPHTHONG**". The three-in-one phonetics shall be represented in Modern English alphabet as below.

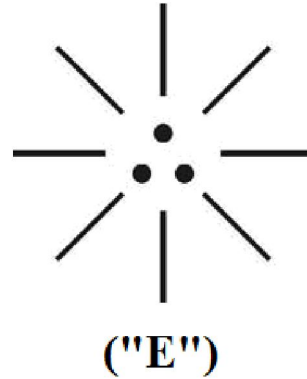

It is further focused that there are so many theories exist for origin of word **“aye”**. **Aye** shall mean **“Yes”**. It is hypothesized that the word **“aye” (ay-e)** shall be considered as creator. **“e”** shall mean **“Heart of creator”** pronounced as **“EZHEM”**.

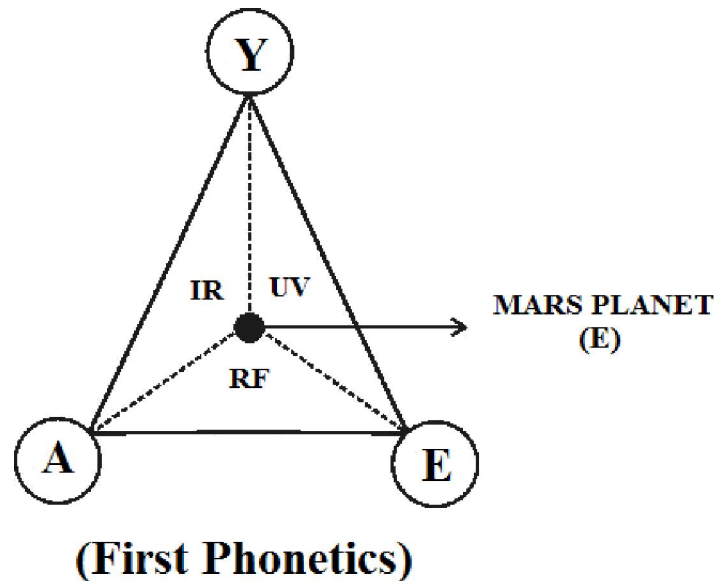

- a) **“E”** shall mean **“MARS”**
- b) **“a”** shall mean **“MOON”**.
- c) **“y”** shall mean **“SUN”**.
- d) **“e”** shall mean **“EARTH”**

It is hypothesized that **“E” (MARS)** shall be considered as the **“WHITE HOLE”** which transform **AKKI-e** particles (fundamental particles) into **“J-RADIATION”** with accelerating force. **J-RADIATION** shall be considered as the **Origin** point of **Photon, Electron, Proton** with **zero mass**. **“J-RADIATION”** shall be considered as emanated from **“E” (EZHEM)**. The Tamil Phonetics **“ERUDHAYAM”**, **“EDHAYAM”** of human heart might be derived from phonetics **“E” or “J”**.

It is focused that **Photon, Electron, Proton** shall be considered as originated from **“E” or “J”**.

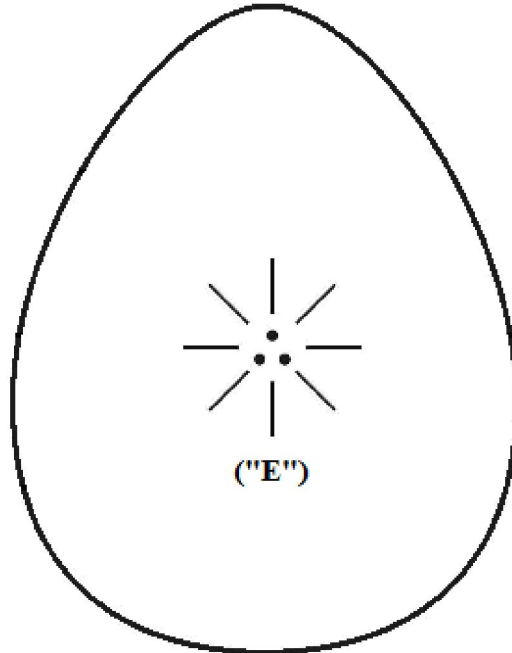

(HUMAN HEART PULSE)

It is further focused that the Prime **Mathematical constants J, I, e, π** , shall be considered closely associated one another.

- | | | |
|--|---|-------------------------|
| i) “ J ” shall mean | - | Joule |
| ii) “ I ” shall mean | - | Photon (Sun) |
| iii) “ e ” shall mean | - | Electron (Earth) |
| iv) “ π ” shall mean | - | Proton (Moon) |

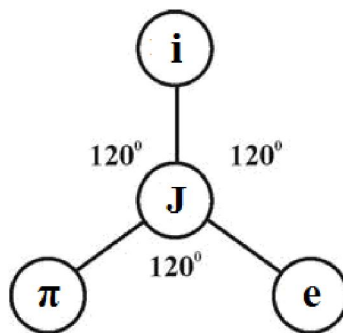

(Universal Constants)

It is hypothesized that in the early universe the value of π , **e** might be rational (Say 3.0) and equal due to Balanced Pollution free environment. During the course of minute expansion and growth of “**New Matters**” the value of **e**, π considered consistently varying inversely proportional to each other due to asymmetry.

“The philosophy of “aye” shall mean estimated “Voting” of Total Particles of Universe”.

- Author.

5. Hypothetical Narration

a) Philosophy of word Minister?...

It is hypothesized that the philosophy of English word “**Minister**” might be derived from the philosophy of prehistoric tamil phonetics “**Min-thiri-e**”

- i) “**Min**” shall mean “fundamental particles”
- ii) “**Thiri-e**” shall mean “Radiation”
- iii) **Min-Thiri-e** shall mean “**E-ACHI**” or **Divine rule**

b) Philosophy of word Policy?...

The term “**Policy**” refers to a plan of action agreed (or) chosen by a political party, a business etc. Further the term police, policing refers to the activity of keeping in order in a place. It is focused that the philosophy of **policy, police, polite, polit buro** might be derived from the philosophy of “**PAL-e**” accessing the periodical growth of particles in the universe.

c) Philosophy of word POLL?...

The English word POLL refers to the process of “**Voting**” in the election to get information about the general opinion of the people.

In **mars family**, it is hypothesized that **ACHI** shall be considered as highly dominant and Father, children of the family shall be considered ruled just by “**EVR**” (Eye vision rule) and thereby concluding final opinion or decision and framing strategy of operations.

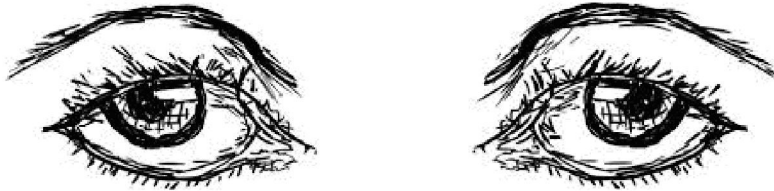
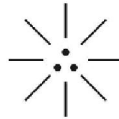

(EVR-ACHI, IAS)

d) Philosophy of parliament?...

The English word Parliament refers to the group of people who are elected to make and change the laws of country. It is focused that the philosophy of Parliament (Supreme court, Lok saba, Rajya saba) related to structural, functional, law part might be derived from the philosophy of “**PAL-e**”.

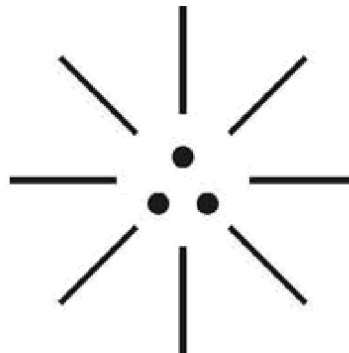

(PAL-e)

- i) Right Wing - **Functional**
- ii) Left Wing - **Structural**
- iii) Centre Wing - **Law Part**

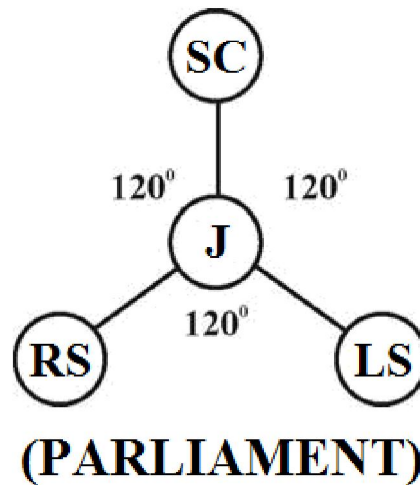

It is further focused that the philosophy of word PAL, Palaeo, Paleolithic, Paleolithic, Pale, Paleface, Pal my might be derived from the philosophy of **Pal-e**.

e) UNIVERSE IS LIKE PARLIAMENT?...

It is hypothesized that the material universe (Region III) shall be considered like a **Parliament**. The etymology of Parliament might be derived from prehistoric Tamil Phonetics "**PAR-e**".

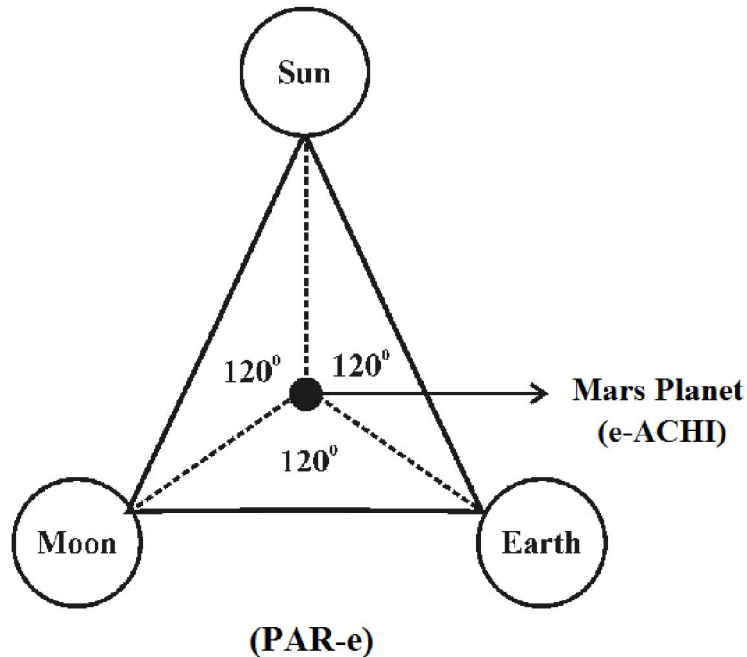

- i) "SUN" is like "Photon dominated".
- ii) "EARTH" is like "Electron dominated".
- iii) "MOON" is like "Photon dominated".
- iv) "MARS" is like "E-ACHI".

f) MOTHER'S WOMB IS LIKE PARLIAMENT?...

It is hypothesized that Mother's Womb shall be considered as **Parliament** having different functions in different regions.

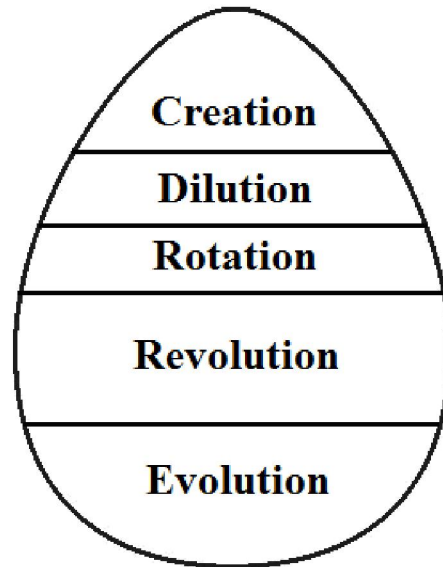

(Mother's Womb)

g) Philosophy of Tri-colour Parliament?...

It is hypothesised that different regions of Parliament shall be considered identified by fundamental **“TRI-COLOUR CODE”**.

- i) Supreme Court - **“BLUE”**
- ii) Lok Saba - **“GREEN”**
- iii) Rajya Saba - **“RED”**

h) Philosophy of Pole?...

The English word **“Pole”** refers to either of two at the opposite ends of the line on which the earth or any other Planets turns. It is focused that the philosophy of **Pole** might be derived from the philosophy of **“Pal-e”**. It is focused that the cosmo Universe shall be considered as having trinity pole and all the three regions of pole shall be called as **WHITE POLES (Trinity Base)**.

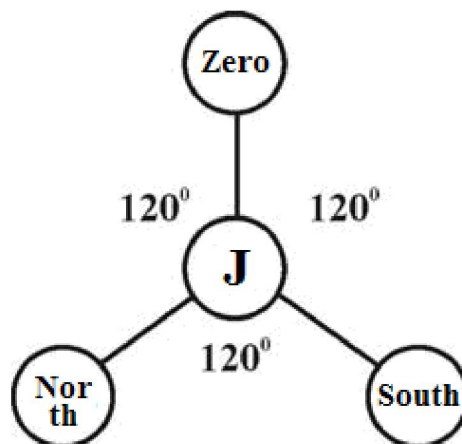

(PAL-e)

Similarly the philosophy or other words polar, Polarity, Polaroid, pole axe, Polemic, Polemical, Pole stat, Pole vault, might be derived from the philosophy of **“PAL-e”**.

i) Philosophy of word Axiom?...

The English word Axiom refers to the rule (or) principle that most people believe to be True. If is focused that the philosophy of Axiom might be derived from the prehistoric Tamil phonetic “**Ayes**” (IAS). **Ayes** shall mean ACHI, AMMA.

j) Philosophy of word “AXION”?...

The English word “AXION” refers to a PARTICLE smaller than an atom which is very light and has no electrical charge. It is focused that the philosophy of AXION might be derived from the philosophy of “**Akki-e**”

k) Philosophy of ENDOS?...

It is hypothesized that **ENDOS** shall be considered as the prehistoric population lived in “**MARS PLANET**”. The **ENDOS** shall be considered as Divine Populations lived in peaceful environment with “**Close eyes**”. In Prehistoric Tamil the philosophy of **ENDOS** shall mean “**CHULARCHI**” (Rotation).

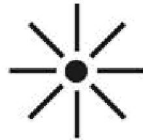

CHULARCHI
(Rotation)

l) Philosophy of INDOS?...

It is hypothesized that “**INDOS**” shall be considered as the 1st generation human populations lived on “**EARTH PLANET**” with different genetic characteristics.

It is focused that the “**ENDOS**” at one stage sensed that how long we can live with closed eyes and decided to “**Open eyes**” with new genetic structure. The philosophy of “**INDOS**” in prehistoric Tamil shall be called as “**PURACHI**” (Revolution)



PURACHI
(Revolution)

The philosophy of “**INDOS**” shall be defined within the following scope.

- i. **INDOS** shall mean “**1st generation Human**”
- ii. **INDOS** shall mean lived on “**EARTH PLANET**”
- iii. **INDOS** shall mean “**PLASMA ENDOS**”
- iv. **INDOS** shall mean start of “**Opening eyes**”
- v. **INDOS** shall mean origin point of “**Revolution**”
- vi. **INDOS** shall alternatively mean “**PURACHI**”

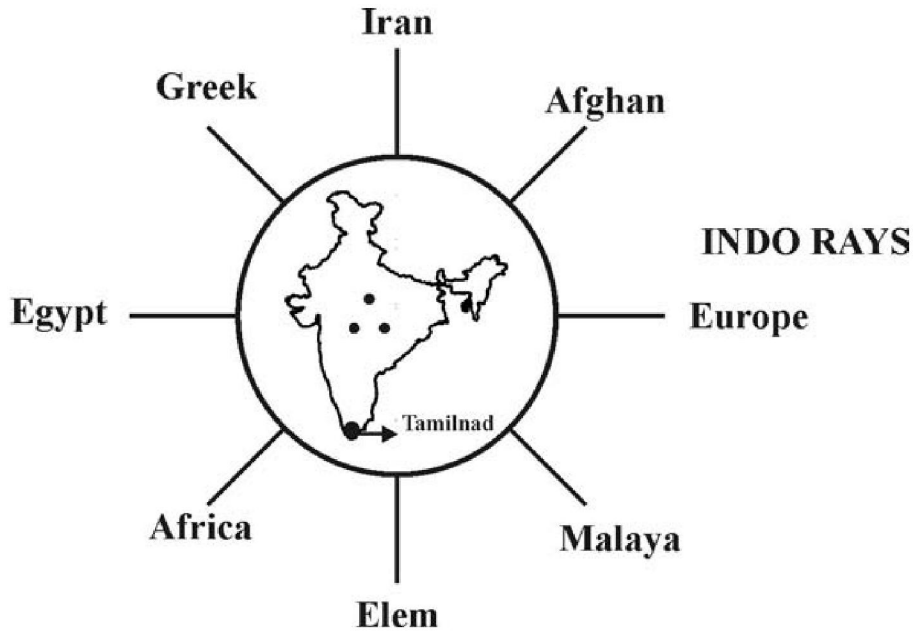

(MARS FAMILY SPECIES)

*The philosophy of English word Purge, Putt, Pursue, Purple Heart, Purist, Purim, might be derived from the philosophy of Tamil phonetics PURACHI.
- Author*

m) Philosophy of ECTO?...

The English word “ECTO” refers to external development (or) Growth. The philosophy of “ECTO” shall be considered derived from the philosophy of prehistoric Tamil phonetics “VALARCHI” (EVOLUTION)

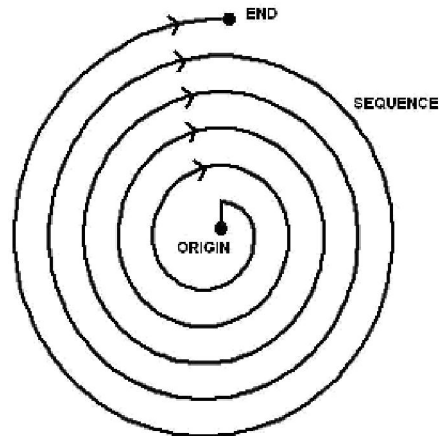

**VALARCHI
(Evolution)**

The philosophy of ECTO (Valarchi) shall be defined within the following scope.

- i. ECTO shall mean state of “Opened eyes”

- ii. ECTO shall mean **Modern human**
- iii. ECTO shall mean **2nd 3rd generation human**
- iv. ECTO shall mean **“External Environment”**

“The philosophy of English word Ecosystem, ecotype, ectomy, ectoplasm, ectopic might be derived from the philosophy of “VALARCHI.”

– Author

n) Philosophy of Initial?...

The English word “Initial” refers to the beginning (or) the first letter of a person’s name. It is focused that the philosophy of affixing initial to the name might be derived from the differences of INDO family when lived in EARTH PLANET.

o) Trinity Principle of Thiruvalluvar?...

It is focused that the trinity principle of Thiruvalluvar **ARAM, POPUL, INDAM**, shall be considered as the 3rd generation philosophy of Life (**MU-PAL**) might be derived from the philosophy of **“PAL-e”**.

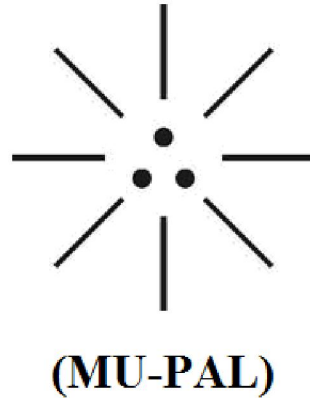

- i) **ARAM** - “Photon” (Dual gender)
- ii) **INBAM** – “Electron (Female gender)
- iii) **PORUL** – ‘Proton” (Male gender)

It is further focused that the **“EZHEM TAMIL”** spoken by 1st generation shall be considered as **lengthy pronounce culture** with extra tablets. During the period of Thiruvalluvar modified grammer system might be adopted with reduction of Tablets.(e.g.) **ACHEEE... ACHEEE...** might become **ACHI...**

p) Philosophy of MU-VENDAR?...

It is hypothesized that the philosophy of Mu-vendar shall be considered as three genetically varied population derived from **“MARS Family”** in three Ages.

- i) **“Achen”** is like **Photon** dominated.
- ii) **“Ayyer”** is like **Electron** dominated.
- iii) **“Ayyanagar”** is like **Proton** dominated.

Sl.No.	Generation	Father	Family
1	Origin	Ay-e	Thai-e family (MARS)
2	1 st Generation	Achen	Achi family
3	2 nd generation	Ayyar	Ammoo family
4	3 rd generation	Ayyanagar	Amma family

q) Philosophy of Mu-Kani?...

It is focused that the philosophy of “**Mu-Kani**” might be derived from the philosophy of “**PAL-e**”.

The philosophy of “**Mu-Kani**” shall be considered as concerned with scientific study of fundamental particles of Universe in early universe.

- i) “**MANGO**” is like “**MATHS**” (Photon)
- ii) “**BANANA**” is like “**CHEMISTRY**” (Electron)
- iii) “**JACK FRUIT**” is like “**PHYSICS**” (Proton)

r) Philosophy of MANAGER?...

It is focused that the philosophy of English word **Manager** might be derived from the prehistoric Tamil phonetics MARS, MAAN. MARS, MAAN shall mean “**Expert**” in creation. Similarly the philosophy of “**MANIYAM**” to the poor shall mean creation of “**Peace**” through Discount offer. The philosophy of **Subsidy, Incentive** shall be considered derived from “**MARS FAMILY**”.

s) Philosophy of STRATEGY?...

The philosophy of strategy refers to a plan that is intended to achieve a particular purpose (e.g.) to develop a strategy for dealing with unemployment, advancement in education, research, etc.

It is focused that the philosophy of “**strategy**” might be derived from the philosophy of “**PAL-e**”.

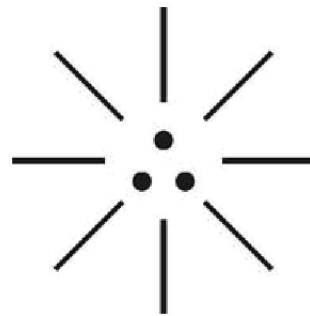

(STRATEGY)

- i) Photon is like “**WISDOM**” (Philosopher)
- ii) Electron is like “**KNOWLEDGE**” (Manager)
- iii) Proton is like “**COMMON SENSE**” (Leader)

t) Who is the creator of E-Achi?...

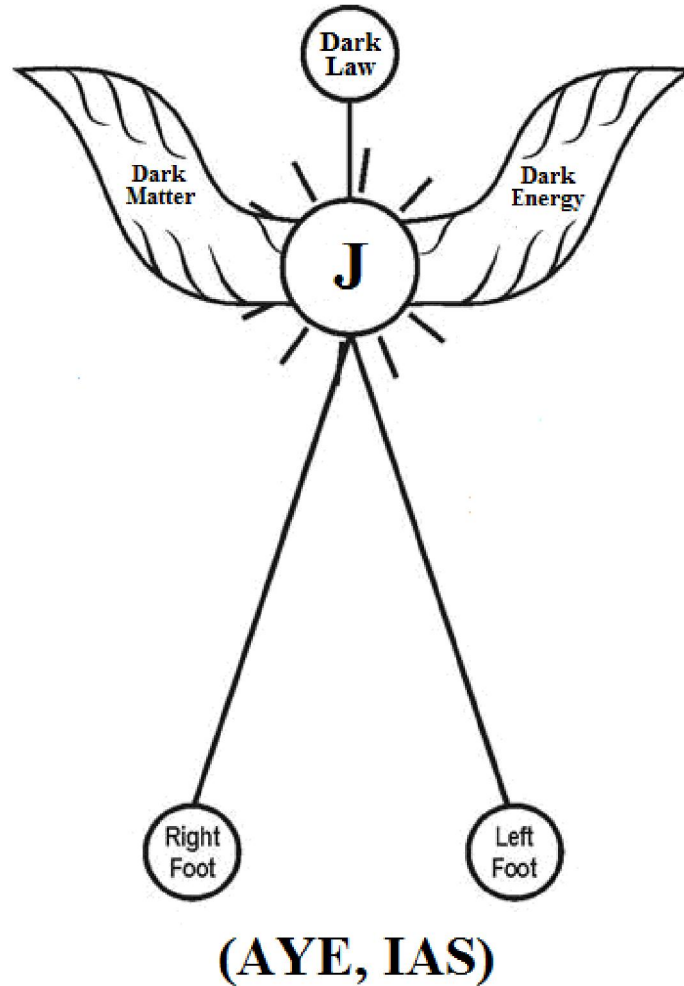

DARK MATTER is like **“HOPE”**
 DARK ENERGY is like **“MERCY”**
 DARK LAW is like **“LOVE”**

6. CONCLUSION:

In the early universe all the initially created matter shall be considered as **“Nursery”** Plants. During the course of time the Nursery plants started searching for lights for their growth and yielding fruits.

It is focused that the Mother’s womb shall be considered like **“visible universe”** and **“Transforms”** created **SOUL** in the form of Embryo into useful product in three trimester. The three **“trimester”** shall be considered like three nuclear age, geological periods before yielding **“Infant”** from Embryo origin. The three stage process shall be called as **“e-politics”**.

- i) Origin – embryo (ENDO)
- ii) Dilution – Plasma Embryo (Indo)
- iii) Ist Trimester – Indo Stage 1
- iv) 2nd Trimester – Indo Stage 2
- v) 3rd Trimester – Indo stage 3
- vi) Release - Jack fruit like Baby

“Motherhood shall be considered as a process of transformation and creation rather than releasing Jackfruit like Baby”.

- **Author.**

7. REFERENCE

- a) Intensive Internet “e-book” study through, Google search and wikipedia
- b) M.Arulmani, “3G Akkana Man”, Annai Publications, Cholapuram, 2011
- c) M. Arulmani; V.R. Hemalatha, “Tamil the Law of Universe”, Annai Publications, Cholapuram, 2012
- d) Harold Koontz, Heinz Weihriah, “Essentials of management”, Tata McGraw-Hill publications, 2005
- e) M. Arulmani; V.R. Hemalatha, “First Music and First Music Alphabet”, Annai Publications, Cholapuram, 2012
- f) King James Version, “Holy Bible”
- g) S.A. Perumal, “Human Evolution History”
- h) “English Dictionary”, Oxford Publications
- i) Sho. Devaneyapavanar, “Tamil first mother language”, Chennai, 2009
- j) Tamilannal, “Tholkoppiar”, Chennai, 2007
- k) “Tamil to English Dictionary”, Suravin Publication, 2009
- l) “Text Material for E5 to E6 upgradaton”, BSNL Publication, 2012
- m) A. Nakkiran, “Dravidian mother”, Chennai, 2007
- n) Dr. M. Karunanidhi, “Thirukkural Translation”, 2010
- o) “Manorama Tell me why periodicals”, M.M. Publication Ltd., Kottayam, 2009
- p) V.R. Hemalatha, “A Global level peace tourism to Veilankanni”, Annai Publications, Cholapuram, 2007
- q) Prof. Ganapathi Pillai, “Sri Lankan Tamil History”, 2004
- r) Dr. K.K. Pillai, “South Indian History”, 2006
- s) M. Varadharajan, “Language History”, Chennai, 2009
- t) Fr. Y.S. Yagoo, “Western Sun”, 2008
- u) Gopal Chettiar, “Adi Dravidian Origin History”, 2004
- v) M. Arulmani; V.R. Hemalatha, “Ezhem Nadu My Dream” - (2 Parts), Annai Publications, Cholapuram, 2010
- w) M. Arulmani; V.R. Hemalatha, “The Super Scientist of Climate Control”, Annai Publications, Cholapuram, 2013, pp 1-3

3/12/2014